

PRODUCT CATALOGUE

- + Active respiratory gas humidification
- + Breathing sets heated
- + Breathing sets unheated
- + nCPAP therapy for infants
- + Patient interfaces
- + Accessoires



QUALITY BORN
FROM PASSION

SUSTAINABLE
PRODUCTION

www.wilamed.com

INDIVIDUAL
SOLUTIONS

Medu
SVERIGE

WILAmEd

A company of
LÖWENSTEIN



Decision-makers, healthcare professionals, and specialists need clear and concise information to quickly and easily select the right equipment for a wide range of respiratory therapy treatments.

Our product range reflects years of insights gained from hospitals worldwide.



QUALITY BORN FROM PASSION

WILAméd products not only comply with legal medical technology standards but are also measured against our own strict quality requirements.



SUSTAINABLE PRODUCTION

Modern, environmentally friendly production facilities and manufacturing processes, social responsibility, and sustainable investments at our Germany location ensure consistent product and process quality at the highest level.

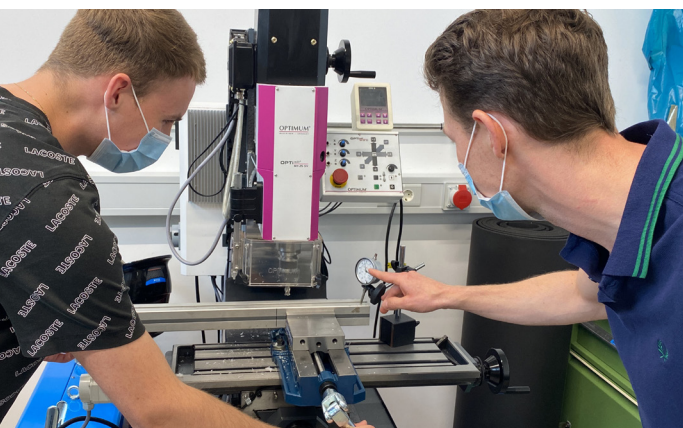

OPTIMIZED SOLUTIONS

The result is perfectly coordinated products that ensure the best possible patient care.

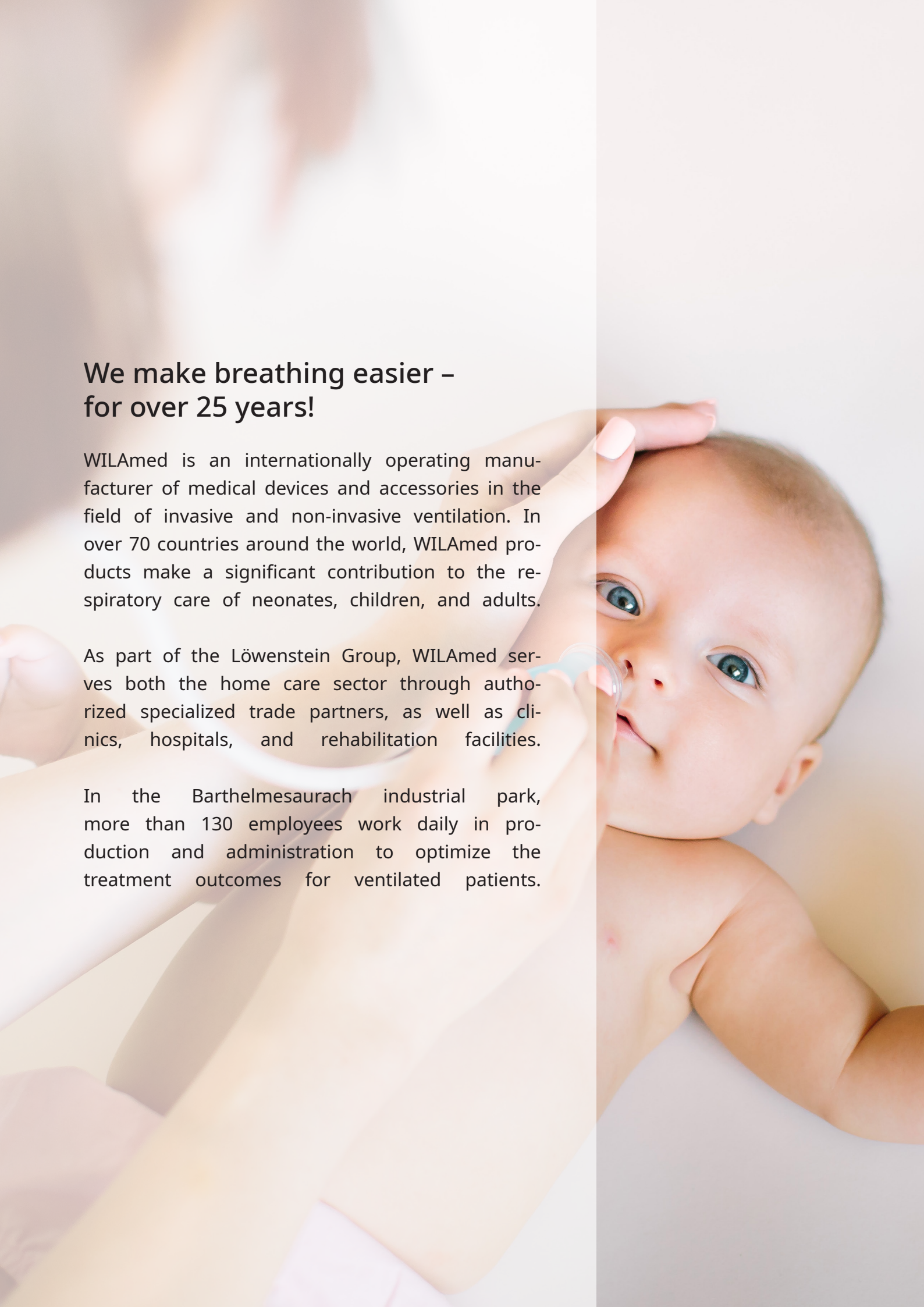

A photograph of a baby lying down, being held by a person whose hands are visible. The baby is looking towards the camera and has a clear plastic bottle in their mouth. The background is a soft, out-of-focus light color.

We make breathing easier – for over 25 years!

WILAméd is an internationally operating manufacturer of medical devices and accessories in the field of invasive and non-invasive ventilation. In over 70 countries around the world, WILAméd products make a significant contribution to the respiratory care of neonates, children, and adults.

As part of the Löwenstein Group, WILAméd serves both the home care sector through authorized specialized trade partners, as well as clinics, hospitals, and rehabilitation facilities.

In the Barthelmesaurach industrial park, more than 130 employees work daily in production and administration to optimize the treatment outcomes for ventilated patients.

TABLE OF CONTENTS

CLINICAL

ACTIVE RESPIRATORY GAS HUMIDIFIERS.....	5
BREATHING SETS HEATED - DOUBLE LIMB	8
BREATHING SETS HEATED - DOUBLE LIMB NEO	10
BREATHING SETS HEATED - SINGLE LIMB	13
HUMIDIFICATION CHAMBERS	18
MECHANICAL AIR / OXYGEN BLENDERS	20
STERILE WATER FOR VENTILATION AND INHALATION.....	21
MOUNTS & BRACKETS FOR HUMIDIFIERS	22
WILAFLOW ELITE NIV INFANT CPAP	25
WILAFLOW ELITE NIV INFANT CPAP ACCESSORIES.....	26
MEDICAL GAS HOSES	30

VENTILATION

BREATHING SETS HEATED - HOME CARE.....	31
BREATHING SETS UNHEATED - HOME CARE	45
DISPOSABLE PATIENT INTERFACES.....	54

SLEEP THERAPY

BREATHING SETS HEATED.....	58
BREATHING SETS UNHEATED	59
HEAD GEAR FOR PATIENT INTERFACES	60
ACCESSORIES.....	62

If you have any questions about our product, please feel free to contact your WILAméd representative.

The images are for illustration purposes only..

,Procedure pack' means a combination of devices packaged and marketed together and intended for use for a specific medical purpose.



ACTIVE RESPIRATORY GAS HUMIDIFIERS

AIRcon Gen2 Humidifier



The **WILAmEd respiratory gas humidifier AIRcon Gen2** is an effective complete solution for optimal respiratory gas humidification of mechanically ventilated patients (both invasive and non-invasive)

By warming and humidifying the respiratory gas, the natural cleaning function of the lungs, known as mucociliary clearance, is supported.

This effectively reduces the risk of pulmonary infections or damage to lung tissue.

The extensively developed AIRcon Gen2 is one of the most advanced respiratory gas humidifiers currently available on the market.

As a fully equipped respiratory gas humidification set, the AIRcon Gen2 can be installed quickly and easily with its extensive accessories, ensuring a safe operation.

The **AIRcon humidifier series** has been well received by healthcare professionals since 2010 – whether in critical care or home ventilation.

Scope of delivery:

- Heater Base / main unit
- Reusable Temperature Probe
- Reusable Heater Wire Adapte

Item	Part number	QTY	GTIN
AIRcon Gen2 humidifier 220 - 240 V Version	101200	1	4055146013182
AIRcon Gen2 humidifier 110 - 120 V Version	101201	1	4055146013199



AIRniva Humidifier



The **WILAMED respiratory gas humidifier AIRniva** is an effective complete solution for optimal respiratory gas humidification of non-invasively ventilated patients.

By warming and humidifying the respiratory gas, the natural cleaning function of the lungs, known as mucociliary clearance, is supported.

This effectively reduces the risk of pulmonary infections or damage to lung tissue.

Scope of delivery:

- Heater Base / main unit
- Reusable Heater Wire Adapter INSP

Item	Part number	QTY	GTIN
AIRniva humidifier 220 - 240 V Version	100500	1	4055146012314
AIRniva humidifier 110 - 120 V Version	100505	1	4055146013175

Dual Heater Wire Adaptor INSP + EXP



Dual heating wire adapter for WILAMED dual limb sets.

Only for use on the AIRcon humidifier!

Item	Part number	QTY	GTIN
Dual Heater Wire Adaptor INSP + EXP	100929	1	4055146117705



Single Heater Wire Adaptor INSP only



Heating wire adapter only for inspiratory heated WILMed limb sets.

Suitable for use on AIRcon and AIRniva.

Item	Part number	QTY	GTIN
Single Heater Wire Adaptor INSP only	100942	1	4055146800157

Temperature Probe



Suitable for use on AIRcon and AIRniva.

Item	Part number	QTY	GTIN
Temperature Probe 160 cm	100910	1	4055146110560
Temperature Probe 180 cm	100909	1	4055146117712



BREATHING SETS HEATED - DOUBLE LIMB

Breathing set heated double limb, NEO

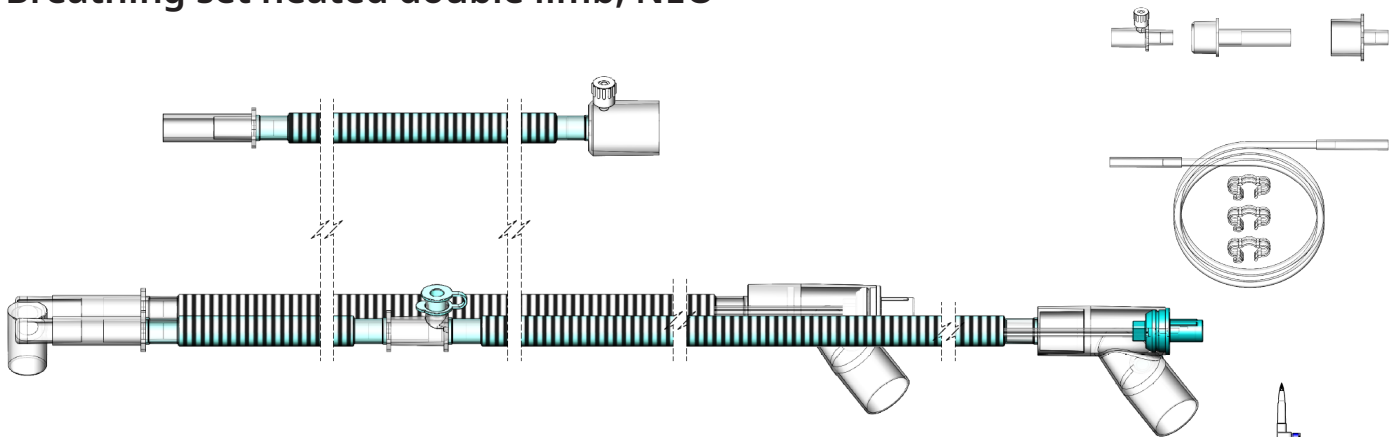

Disposable breathing set heated (i+e), double limb, A-Adapter, with and without autofill chamber, 120cm, 10mm Ø, Connecting tube 60cm

Item	Part number	QTY	GTIN
BTS1154A, including Autofill humidification chamber	27074510	10	4055146032411
BTS1181A, without Autofill humidification chamber	27075410	10	4055146030066

Breathing set heated double limb, NEO

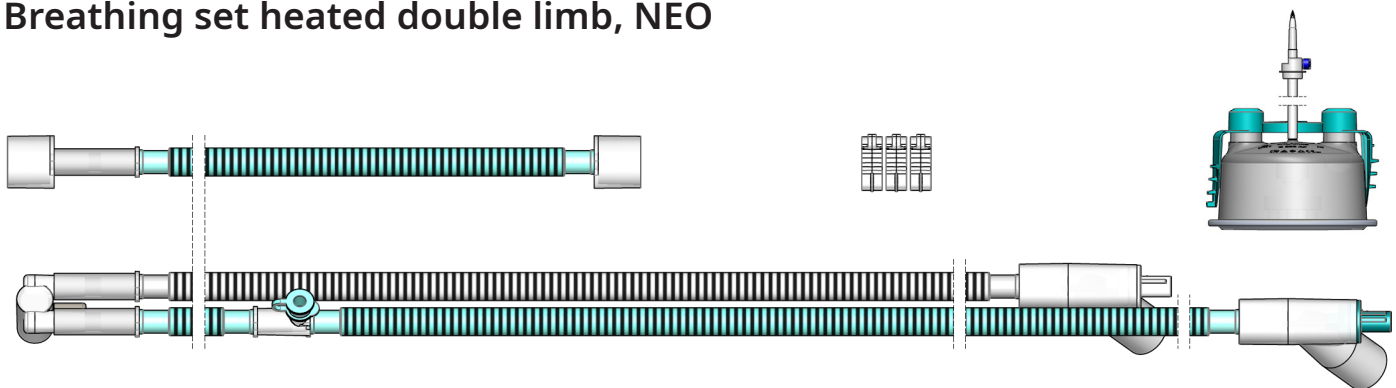

Disposable breathing set heated (i+e), double limb, A-Adapter, with and without Autofill chamber, 120cm, 10mm Ø, Connecting tube 60cm

Item	Part number	QTY	GTIN
BTS1122A, including Autofill humidification chamber	27070510	10	4055146032237
BTS1125A, without Autofill humidification chamber	27070610	10	4055146300015

Breathing set heated double limb, Adults

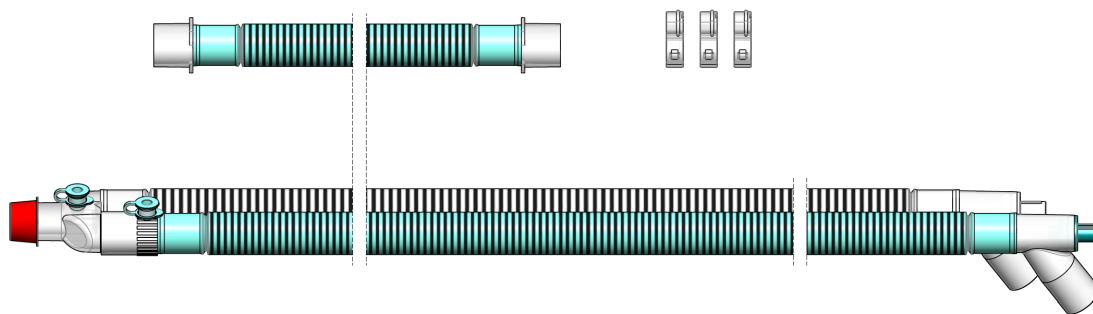

Disposable breathing set heated (i+e), double limb,
with coiled heated wire for AIRcon,
A-Adapter,
Autofill chamber,
150cm, 22mm Ø,
Connecting tube 60cm

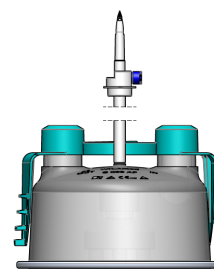

Item	Part number	QTY	GTIN
BTS3481A, including Autofill humidification chamber	27176010	10	4055146300787

Breathing set heated, double limb, Pediatric

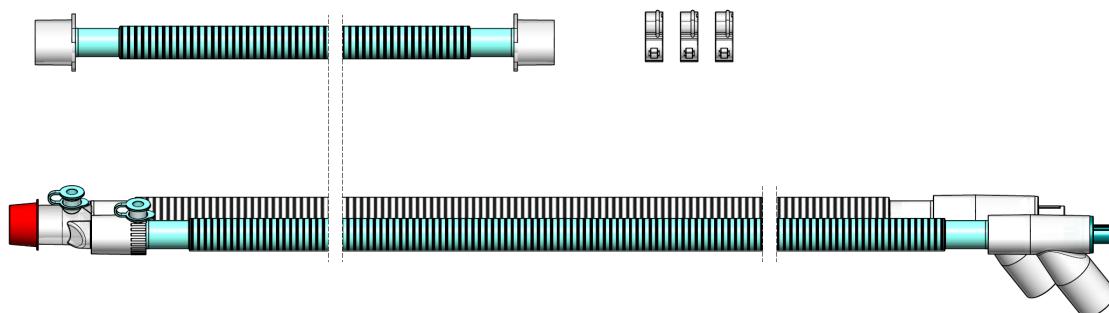

Disposable breathing set heated, double limb (i+e)
with coiled heated wire for AIRcon, A-Adapter,
Autofill chamber,
150cm, 15mm Ø,
Connecting tube 60cm

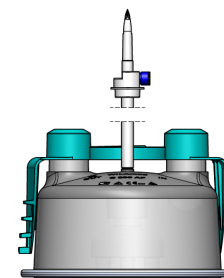

Item	Part number	QTY	GTIN
BTS2260A, including Autofill humidification chamber	27176110	10	4055146300770



BREATHING SETS HEATED - DOUBLE LIMB - NEO

Breathing set heated double limb, NEO for Dräger VN500 HFO

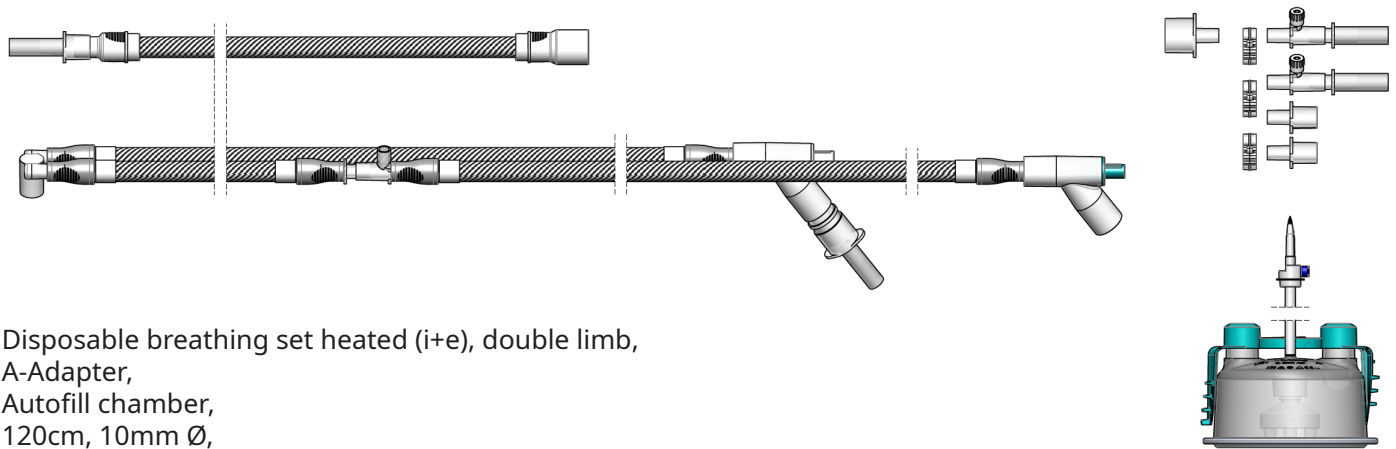

Disposable breathing set heated (i+e), double limb,
A-Adapter,
Autofill chamber,
120cm, 10mm Ø,
Connecting tube 60cm

Item	Part number	QTY	GTIN
BTS1245A, including Autofill humidification chamber	27116310	10	4055146031292

Breathing set heated double limb, NEO for SLE 4000/5000

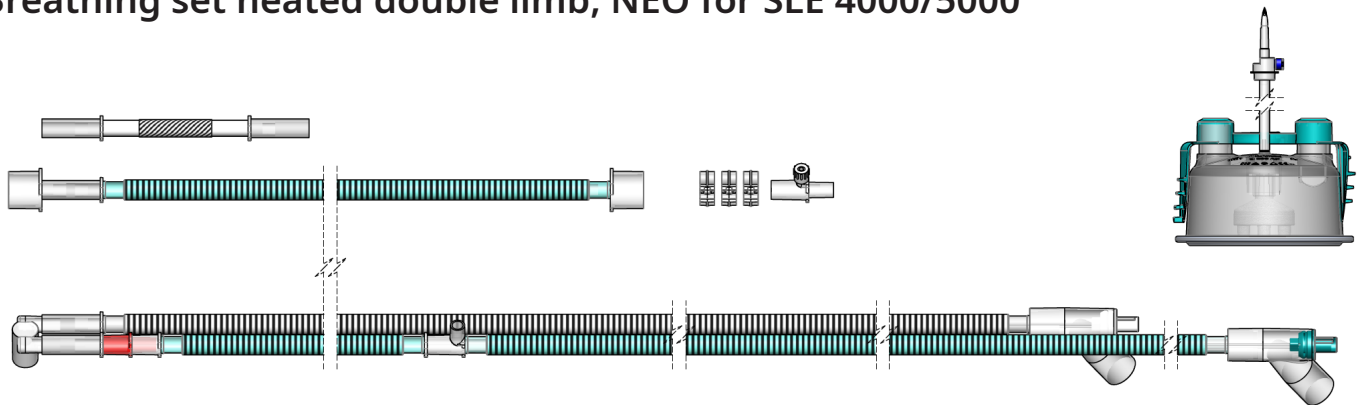

Disposable breathing set heated (i+e), double limb, for SLE4000/5000, heated (i+e),
A-Adapter,
pressure measuring line, T-piece with temperature port,
flow liwither,
Extension tube 40cm,
120cm, 10mm Ø,
Connecting tube 60cm

Item	Part number	QTY	GTIN
BTS1148A, including Autofill humidification chamber	27073910	10	4055146032459



Breathing set heated, double limb, NEO

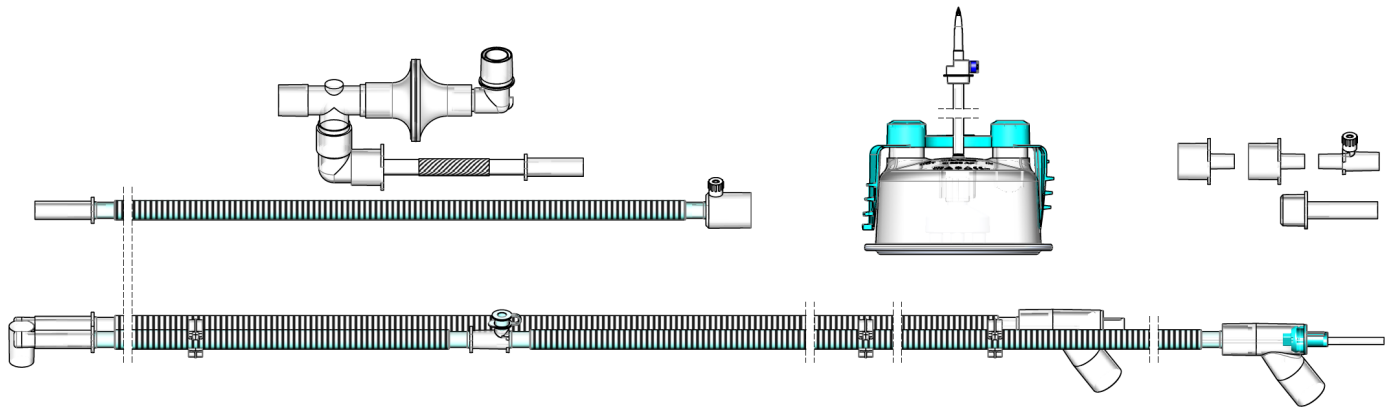

Disposable breathing set heated (i+e), double limb,
 A-Adapter, Autofill chamber, pressure line,
 bacteria filter, HFO kit,
 extension tubing for incubator
 120cm, 10mm Ø,
 Connecting tube 60cm

Item	Part number	QTY	GTIN
BTS1215A, incl. HFO-Kit und Autofill humidification chamber	27079110	10	4055146030141

Breathing set heated, double limb, NEO

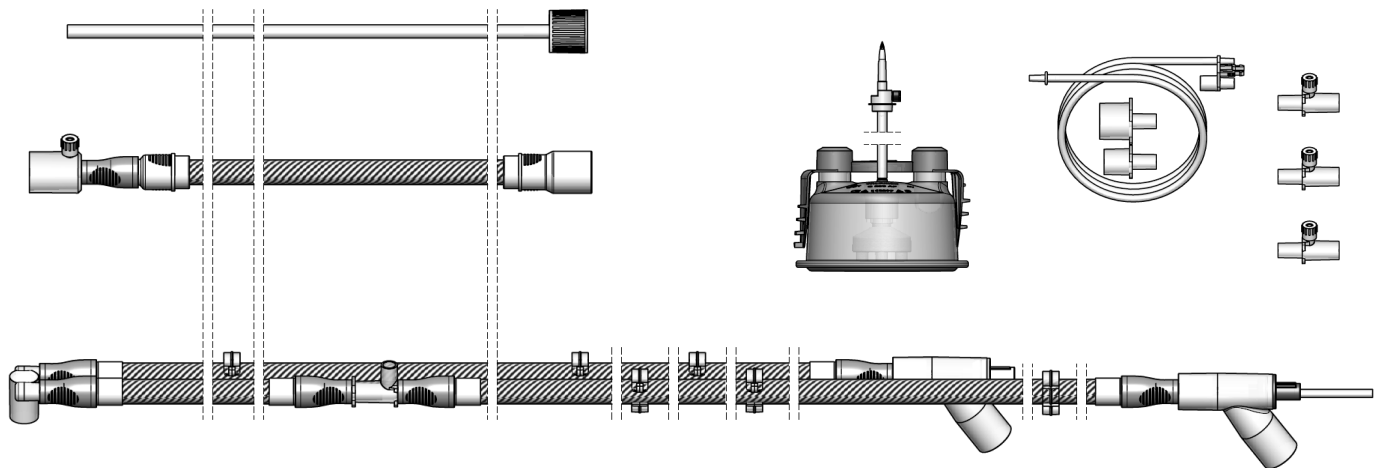

Disposable breathing set heated (i+e), double limb, for Acutronic Fabian HFO,
 A-Adapter, Autofill chamber AIRcon,
 additional pressure measurement line,
 160cm, 10mm Ø,
 Connecting tube 60cm

Item	Part number	QTY	GTIN
BTS1347A, Breathing set heated (i+e), for Acutronic	27171010	10	4055146300305

Breathing set heated, double limb, NEO for SLE 6000

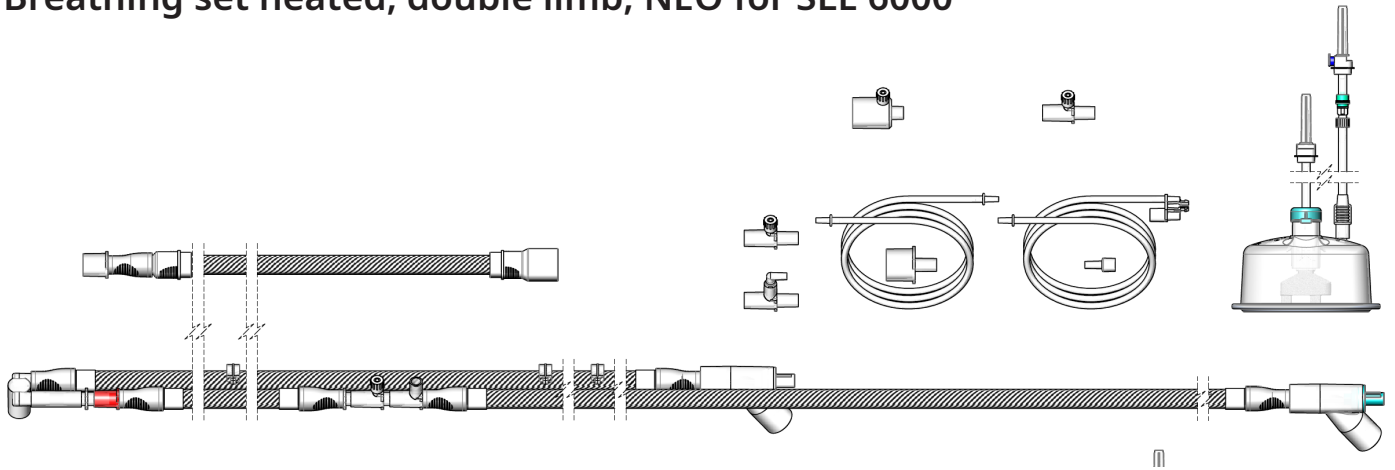

Disposable breathing set heated (i+e), double limb, for SLE 6000,
 A- Adapter, Autofill chamber AIRcon,
 additional pressure measuring line,
 160cm, 10mm Ø,
 Connecting tube 60cm

Item	Part number	QTY	GTIN
BTS1321A, Breathing set heated, SLE 6000,10mm, 160cm	27158710	10	4055146300732

For use with LÖWENSTEIN Leoni Plus

Breathing set heated, double limb

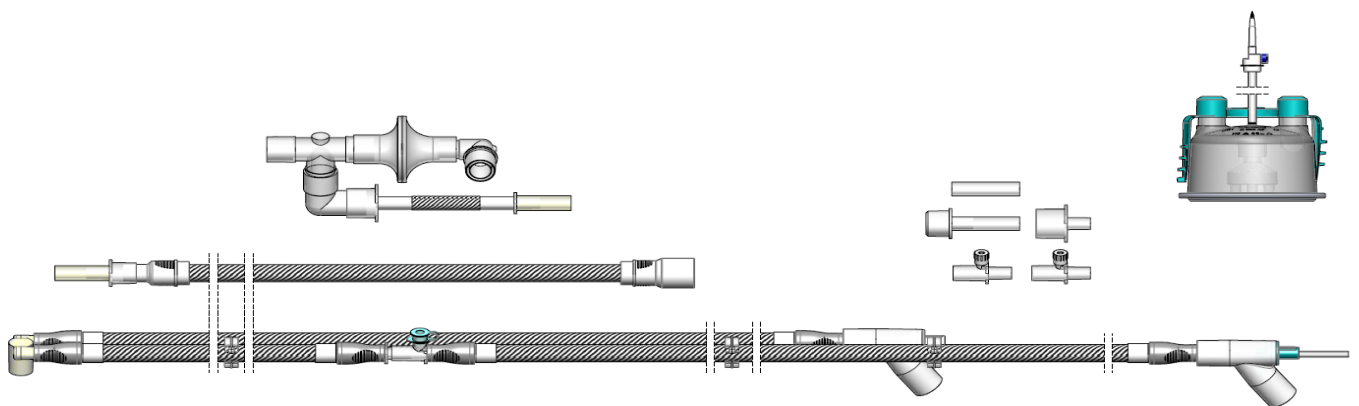

Disposable breathing set heated, double limb,
 Autofill chamber - Ø10 mm, 120 cm

Item	Part number	QTY	GTIN
BTS1241A, Breathing set heated, incl. AF humidification chamber	27114910	10	4055146301722



BREATHING SETS HEATED - SINGLE-LIMB

Breathing set NEO O2 Therapy

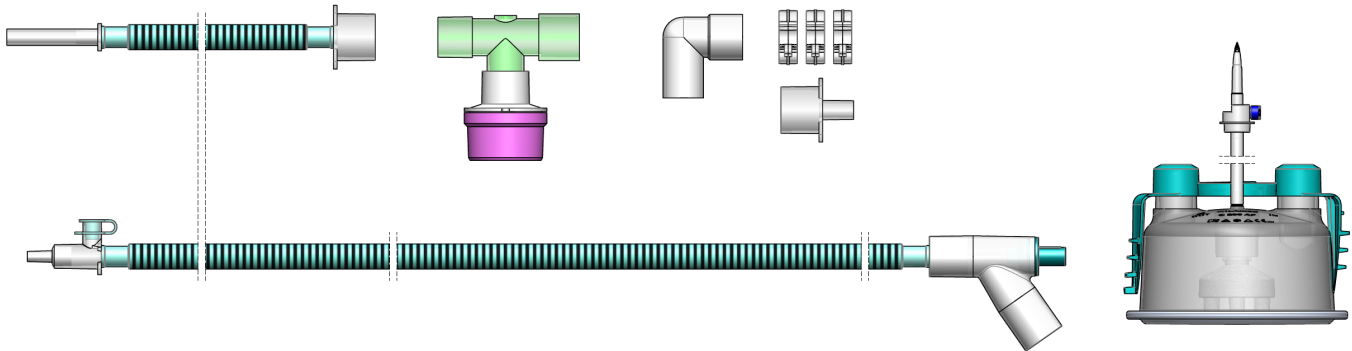

Disposable breathing set heated (i), single limb, A-Adapter, with and without Autofill chamber Aircon, Neo-Adapter, passive valve, O2 Blender, 120cm, 10mm Ø, Connecting tube 60cm

Item	Part number	QTY	GTIN
BTS1307A, Breathing set heated, single limb, humid. chamber	27150610	10	4055146030943
BTS1235A, Breathing set heated, single limb	27150710	10	4055146301708

Procedure pack

* Available in the CE region and other countries upon request.

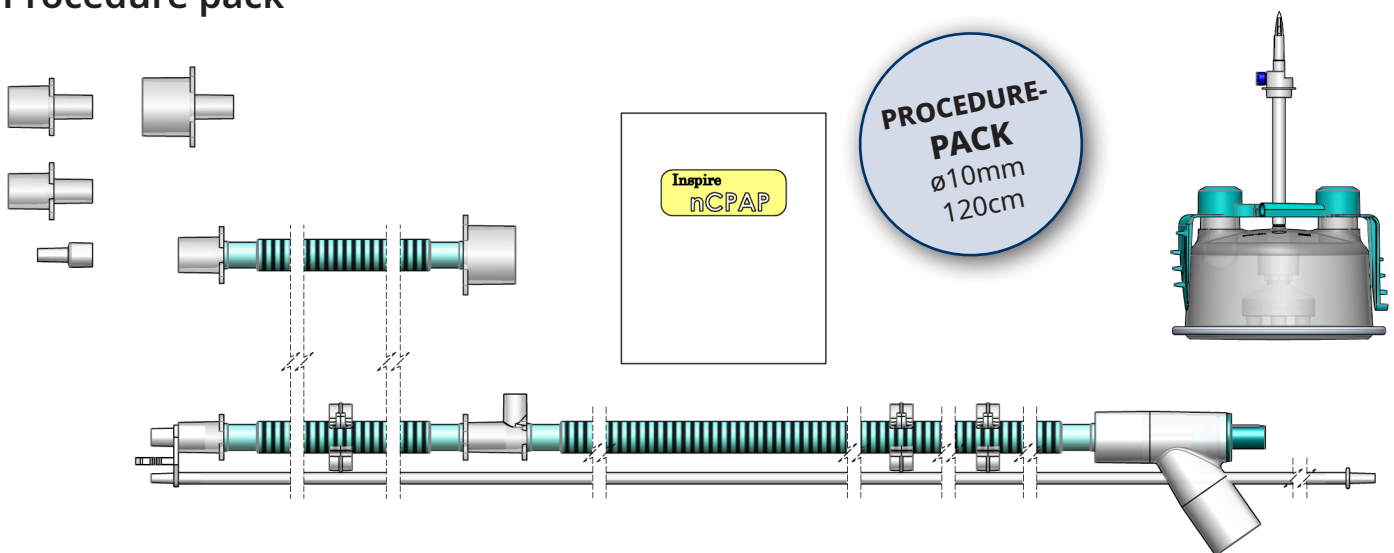

Item	Part number	QTY	GTIN
1x Breathing set, heated (REF 271543 / BTS1310A)	27077710	10	4055146030448
1x Inspire nCPAP generator with prongs (REF IHC600)			



Procedure pack

* Available in the CE region and other countries upon request.

**PROCEDURE-
PACK**
ø10mm
120cm

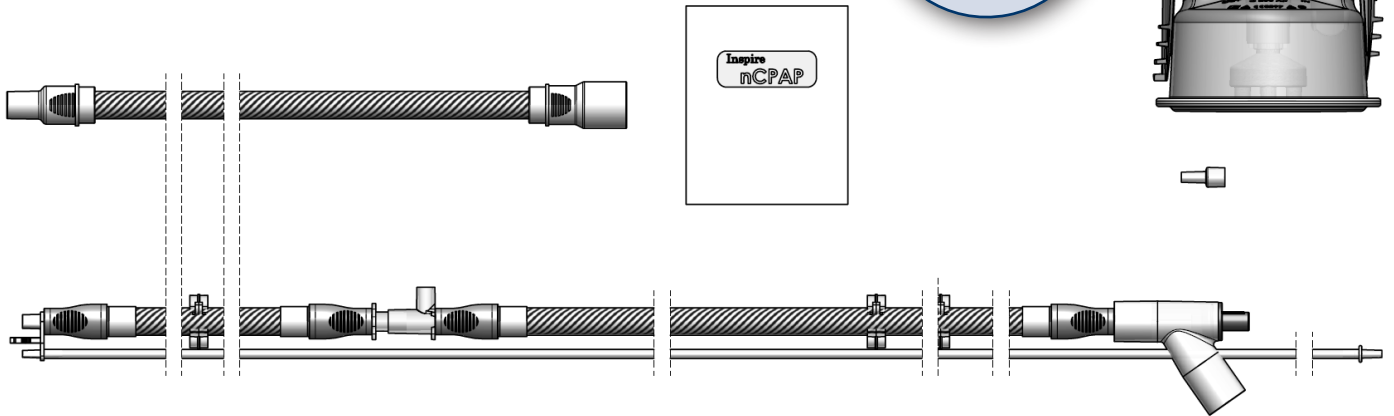

Item	Part number	QTY	GTIN
1x Breathing set, heated (REF 271754 / BTS1359A)	27175310	10	4055146300718
1x Inspire nCPAP generator with prongs (REF IHC600)			

Procedure pack

* Available in the CE region and other countries upon request.

**PROCEDURE-
PACK**
ø10mm
120cm

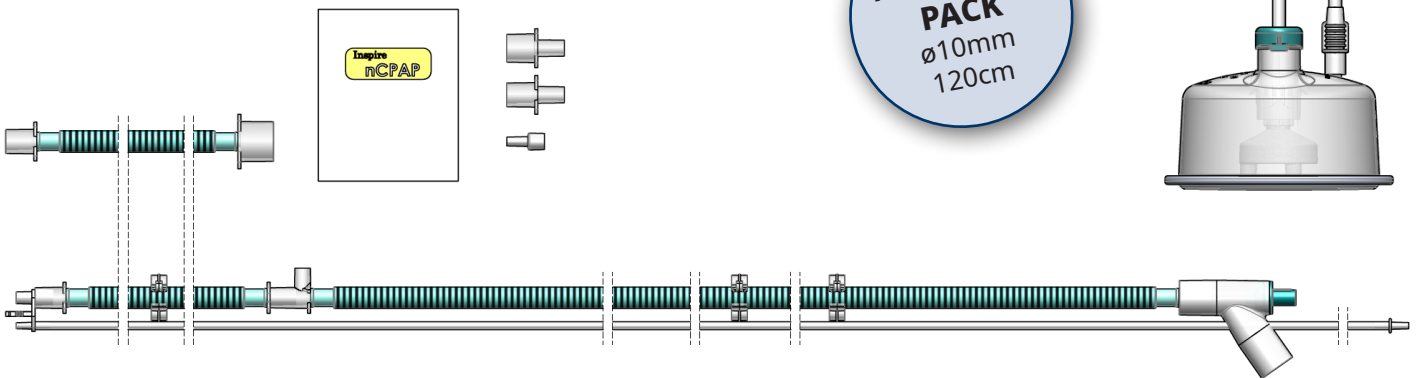

Item	Part number	QTY	GTIN
1x Breathing set heated, double limb (REF 271767 / BTS4044A)	27177410	10	4055146300930
1x Inspire nCPAP generator with prongs (REF IHC600)			



Procedure pack

* Available in the CE region and other countries upon request.

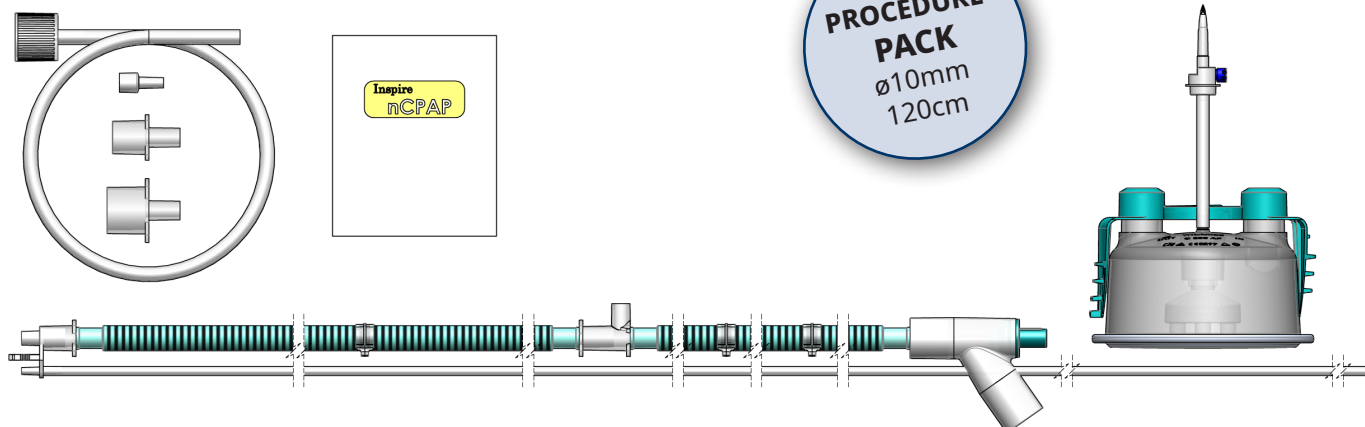

Item	Part number	QTY	GTIN
1x Breathing set heated (REF 271717 / BTS1349A)	27112410	10	4055146031070
1x Inspire nCPAP generator with prongs (REF IHC600)			

Breathing set heated Adults

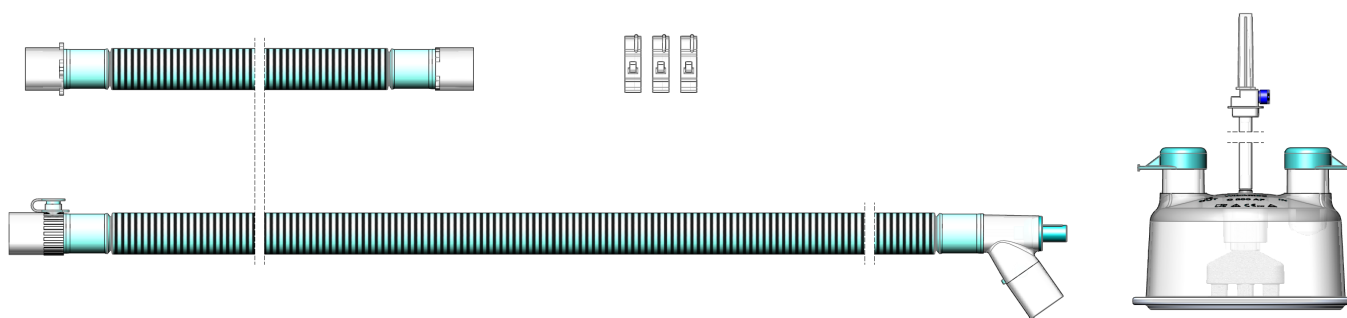

Disposable breathing set heated (i), single limb, for CPAP, A-Adapter, with and without Autofill chamber, 150cm, 22mm Ø, Connecting tube 60cm

Item	Part number	QTY	GTIN
BTS3234A, Breathing set heated, incl. Autofill humidification chamber	27112510	10	4055146031063
BTS3237A, Breathing set heated, without Autofill humidification chamber	27112610	10	4055146031056
BTS3451A, Breathing set heated, incl. Universal Autofill humid. chamber	27165710	10	4055146300084



Breathing set heated, single limb, Pediatric

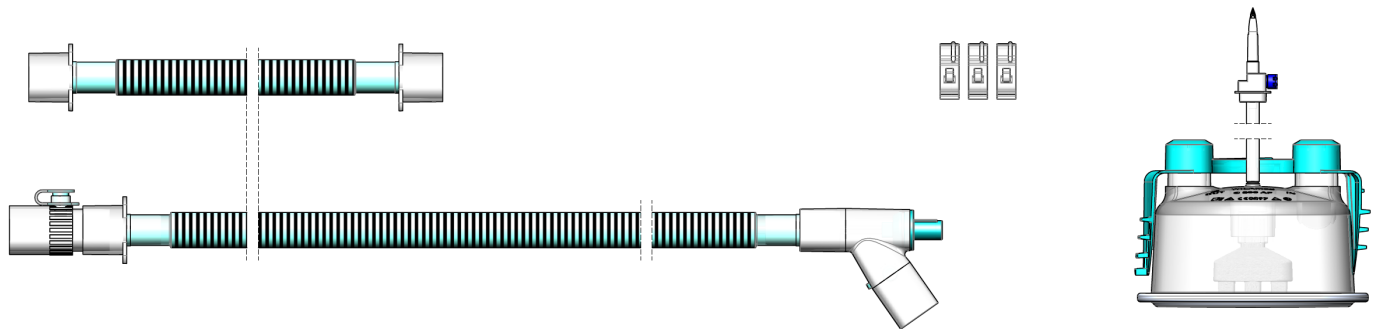

Disposable breathing set heated (i), single limb, for CPAP,
A-Adapter, Autofill chamber Aircon,
150cm, 15mm Ø,
Connecting tube 60cm

Item	Part number	QTY	GTIN
BTS2171A, Breathing set heated, single limb, incl. Autofill humidification chamber	27151910	10	4055146030981

Breathing set heated, single limb, Adults (only for AIRniva)

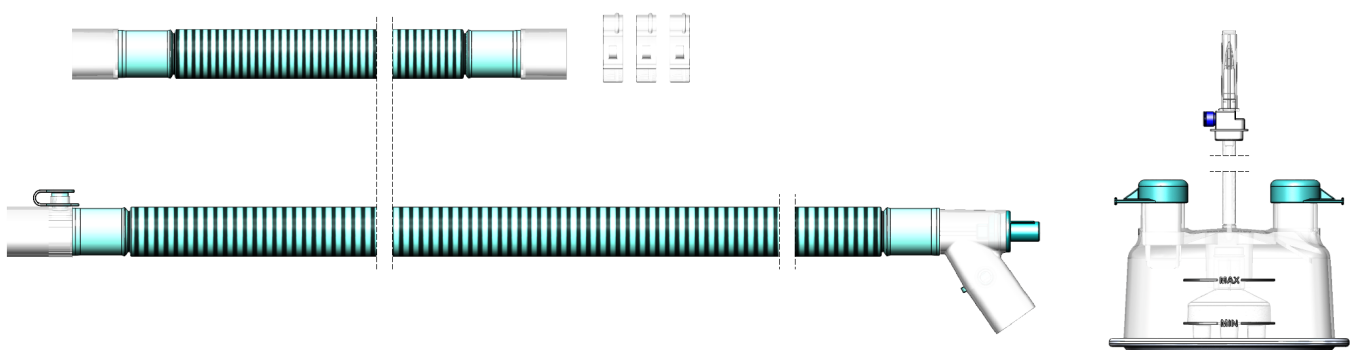

Disposable breathing set heated (i), single limb, for CPAP, O2-Therapy,
A-Adapter, Autofill chamber universal,
O2 Blender,
150cm, 22mm Ø,
Connecting tube 60cm

Item	Part number	QTY	GTIN
BTS3421A, Breathing set heated, incl. Autofill humidification chamber	27157910	10	4055146033104

Breathing set heated, Adults, Disposable for Philips V60

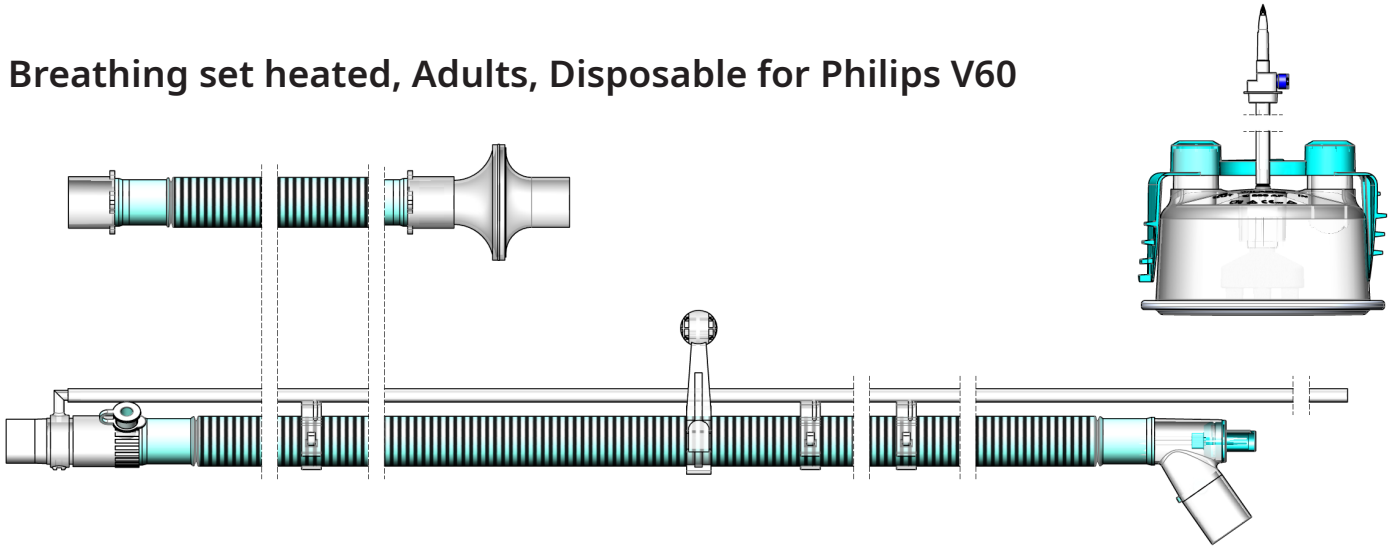

Disposable breathing set heated (i), single limb,
 A-Adapter, Humidification chamber,
 150cm, 22mm Ø,
 passive valve,
 Connecting tube 60cm with arterial filter

Item	Part number	QTY	GTIN
BTS3218A, 150 cm, incl. Autofill hHumidification chamber	27075610	10	4055146030059
BTS3297A, 180 cm, incl. Autofill humidification chamber	27119610	10	4055146030615



HUMIDIFICATION CHAMBERS

The humidification chamber is an essential component of our heated ventilation sets, so the two are also perfectly matched.

Thus, we ensure optimal respiratory gas conditioning for mechanically ventilated patients, both in clinical and non-clinical settings.

The C200AF Auto-Fill humidification chambers guarantee a constant water level, on the one hand due to our sophisticated float set inside the chamber and on the other hand due to the highly precise infrared water level monitoring of the AIRcon.

Our humidification chambers can be ordered individually or as part of a complete ventilation set (convenience kit).

With our sterile water „WILaqua“ we can offer a closed set completely from one source.

C200AF AIRcon Disposable humidification chamber



Disposable Autofill humidification chamber, for all patient groups.

Only suitable for use on AIRcon humidifiers.

Item	Part number	QTY	GTIN
C200AF, Disposable Autofill humidification chamber for AIRcon	50030030	30	4055146750278
C200AFP, Disposable Autofill humidification chamber for AIRcon	50048024	24	4055146750308



C200AF Universal disposable humidification chamber



Autofill disposable humidification chamber for all patient groups.

Item	Part number	QTY	GTIN
C200AF Universal, disposable humidification chamber	50038030	30	4055146750285

Humi.AIDE - Reusable humidification chamber



* Only available in selected markets. Engage for more information.

Manually refillable, reusable humidifier chamber.

Item	Part number	QTY	GTIN
Humi.AIDE, reusable humidification chamber	270958	1	26923980102183



MECHANICAL AIR / OXYGEN BLENDERS

WILAmEd/Biomed Devices oxygen mixers for neonatal and pediatric intensive care units with flowmeters from 3 to 15 LPM, for low and high flow oxygen therapy.

The WILAmEd/Biomed Devices High-Flow Oxygen Blenders are specially designed for Nasal High-Flow Therapy in combination with active respiratory gas humidification (WILAmEd AIRcon). The blender has a flowmeter up to 70 liters per minute and is therefore the perfect solution in Nasal High-Flow Therapy for adults.

Biomed Blender

* Only available in the CE region!



Item	Part number	QTY	GTIN
Biomed NEOblend Blender, incl. Flowmeter up to 15 LPM	100356	1	00813841020478
Biomed High-Flow Blender. incl. Flowmeter 70 LPM	100357	1	00813841020461



STERILE WATER FOR VENTILATION AND INHALATION

WILAqua Sterile Water

* Only available in selected markets. Engage for more information.

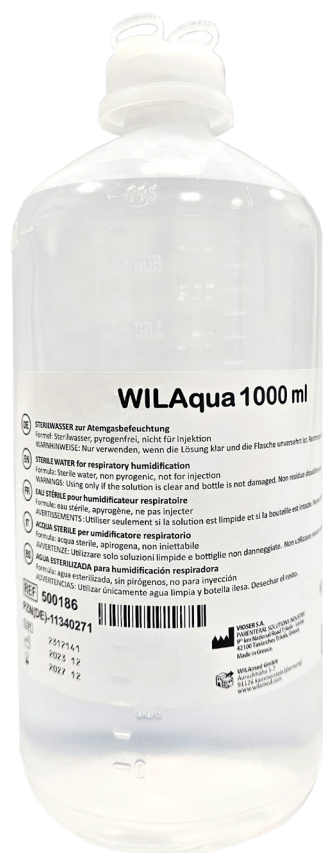

WILAqua sterile water is produced in state-of-the-art manufacturing facilities and has been specially developed to meet the demanding hygienic requirements of invasively and non-invasively ventilated patients. It is distilled sterile water.

Item	Part number	QTY	GTIN
WILAqua Sterile Water for Inhalation, 1.000 ml PE Bottle	500186	10	05200702400589
WILAqua Sterile Water for Inhalation, 1.000 ml PE Bottle	5001862	660	05200702400589



MOUNTS & BRACKETS FOR HUMIDIFIERS

C-clamp for IV stand

* Only available in selected markets. Engage for more information.



Our standard c-clamp is designed to mount horizontally or vertically on round surface (e.g. I.V. poles), with a maximum diameter of 40 mm.

Item	Part number	QTY	GTIN
C-Clamp	550301	1	4055146087244

Mounting Bracket for Norm Rail

* Only available in selected markets. Engage for more information.



Our standard mounting unit is designed, for example, for mounting the AIRcon humidifier on standard rails.

Item	Part number	QTY	GTIN
Mounting Bracket for Norm Rail	550226	1	4055146087848



Mounting Bracket Kit for Norm Rail

* Only available in selected markets. Engage for more information.



Our angled attachment unit is intended, for example, for attaching the AIRcon respiratory gas humidifier to standard rails.

Item	Part number	QTY	GTIN
Mounting Bracket Kit for Norm Rail	550247	1	4055146088562

Telescopic Water Bag Pole

* Only available in selected markets. Engage for more information.



Water bottle holder with telescopic rod and holder for respiratory gas humidifier, for attachment to standard rails in clinical and non-clinical environments.

Item	Part number	QTY	GTIN
Wasserflaschenhalterung with Teleskopstange	550220	1	4055146085967



Biomed C-Clamp

* Only available in selected markets. Engage for more information.



Biomed C-clamp is designed for fixing e.g. the oxygen mixer to infusion stands, with a maximum diameter of 40 mm.

Item	Part number	QTY	GTIN
Biomed Blender Pole Mount C-Clamp	100358	1	4055146200742

Heavy Duty Stand IV-Pole

* Only available in selected markets. Engage for more information.



Heavy duty infusion stand made of stainless steel for use as a mobile equipment carrier such as oxygen mixers, respiratory gas humidifiers, etc., including 4 hooks for attaching sterile water, infusion solutions, etc.

Item	Part number	QTY	GTIN
Heavy Duty Stand with five Casters and IV-Pole	550273	1	4055146087749



WILAFLOW ELITE NIV INFANT CPAP

WILAflow Elite NIV Ventilator



The WILAflow Elite is a ventilator that is used for non-invasive ventilation, such as nCPAP and nasal HiFlow O2 therapy, in premature and newborn infants in the hospital.

The use of nCPAP (a continuous positive airway pressure) is now considered the gold standard for respiratory support in preterm infants. The most common indications include respiratory distress syndrome and apneas. Application via binasal prongs or nasal mask is now considered the internationally validated standard.

WILAflow Elite ventilation modes: SNIPPV (Synchronized), NIPPV, nCPAP, HFNC All accessories and consumables for the WILAflow Elite are available and are described on the following pages.

Scope of delivery:

- WILAflow Elite ventilator
- Tubing support arm
- Supply tree for sterile water
- Signal Box/IEC

Item	Part number	QTY	GTIN
WILAflow Elite NIV Ventilator, incl. Vent Cart	101300	1	4055146013267



WILAFLOW ELITE NIV INFANT CPAP ACCESSORIES

WILAflow Elite Signal Box

* Only available in selected markets. Engage for more information.



Item	Part number	QTY	GTIN
WILAflow Elite Signal Box for Abdominal Sensor	101302	1	4055146800119

WILAflow Elite Body Sensor

* Only available in selected markets. Engage for more information.



Item	Part number	QTY	GTIN
WILAflow Elite Body Sensor VX010 100 CM	101301	5	4055146800171



WILAflow Elite Circuit Support Arm

* Only available in selected markets. Engage for more information.



Item	Part number	QTY	GTIN
WILAflow Elite Circuit Support Arm	101304	1	4055146800133

WILAflow nCPAP Generator

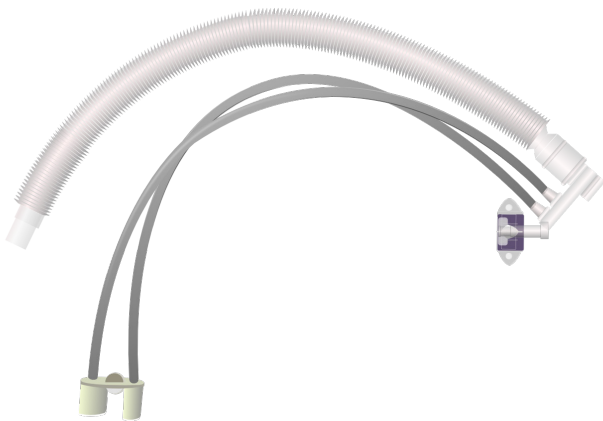

The Fluidic-Flip principle, which has been known and proven for decades when using our CPAP generator, was developed especially for infants and has established itself as the globally recognized gold standard in the non-invasive ventilation of infants, or premature infants.

Our WILAflow nCPAP generator comes with three nasal prongs; 1 x size S, 1 x size M and 1 x size L.

Item	Part number	QTY	GTIN
WILAflow nCPAP generator, incl. 3 prongs (S, M, L)	300660	10	4055146083079



INSPIRE nCPAP Nasal Prongs

* Engage for more information.



Item	Part number	QTY	GTIN
INSPIRE nCPAP Nasal Prong, Size XS	300716	10	5051380008426
INSPIRE nCPAP Nasal Prong, Size S	300712	10	5051380008440
INSPIRE nCPAP Nasal Prong, Size M	300713	10	5051380008464
INSPIRE nCPAP Nasal Prong, Size L	300714	10	5051380008488

INSPIRE nCPAP Mask

* Engage for more information.



Item	Part number	QTY	GTIN
INSPIRE nCPAP Mask, Size S	300710	10	5051380008501
INSPIRE nCPAP Mask, Size M	300711	10	5051380008525
INSPIRE nCPAP Mask, Size L	300708	10	5051380007856
INSPIRE nCPAP Mask, Size XL	300709	10	5051380007870



WILAbonnets



For use in combination with our WILAflow nCPAP generator, our particularly soft, flexible and skin-friendly WILAbonnets are used for optimal fixation of the nCPAP generator during nCPAP therapy.

Item	Part number	QTY	GTIN
WILAbonnet, White, Size 000, 18 - 20 cm	300720	10	4055146200216
WILAbonnet, Grey, Size 00, 20 - 22 cm	300721	10	4055146200223
WILAbonnet, Pink, Size 0, 22 - 24 cm	300722	10	4055146200230
WILAbonnet, Brown, Size 1, 24 - 26 cm	300723	10	4055146200247
WILAbonnet, Yellow, Size 2, 26 - 28 cm	300724	10	4055146200254
WILAbonnet, Blue, Size 3, 28 - 30 cm	300725	10	4055146200612
WILAbonnet, Lite Orange, Size 4, 30 - 32 cm	300726	10	4055146200674
WILAbonnet, Green, Size 5, 32 - 34 cm	300727	10	4055146200537
WILAbonnet, Red, Size 6, 34 - 36 cm	300728	10	4055146200148
WILAbonnet, Orange, Size 7, 36 - 38 cm	300729	10	4055146200049
WILAbonnet, Turquoise, Size 8, 38 - 40 cm	300730	10	4055146200032
WILAbonnet, Dark Blue, Size 9, 40 - 42 cm	300731	10	4055146200155



MEDICAL GAS HOSES

O2 and AIR



ZV hoses for WILMed ventilators for the compressed air and oxygen in ISO32 black and white.

Our ZV hoses convince with durable and uncompromising reliability and offer absolute safety for man and machine.

Item	Part number	QTY	GTIN
O2 Medical Gas Hose, NIST/DIN, white, 3 m	101577	1	4055146800027
AIR Medical Gas Hose, NIST/DIN, black, 3 m	100666	1	4055146083703



BREATHING SETS HEATED - HOME CARE

For use with Resmed Astral Ventilators

Breathing sets heated, single limb, Adults

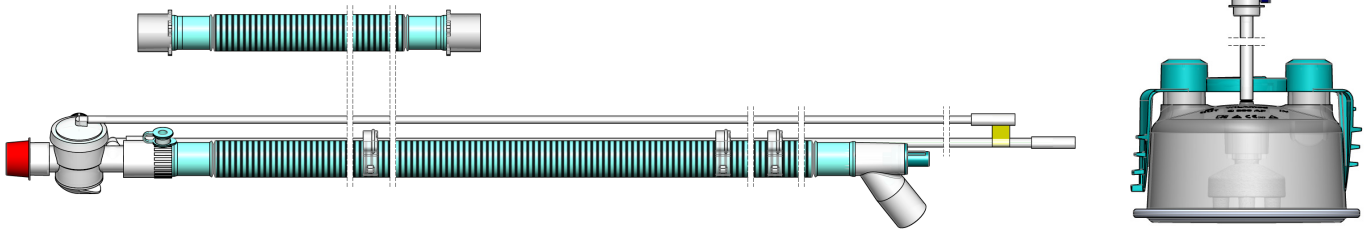

Disposable breathing set heated (i), A- Adapter, Autofill humidification chamber, active valve, 150cm, 22mm Ø, pressure measuring line, control line, Connecting tube 60cm

Item	Part number	QTY	GTIN
BTS3391A, Breathing set heated, incl. AF humidification chamber	27125010	10	4055146032800

Breathing sets heated, double limb, Adults

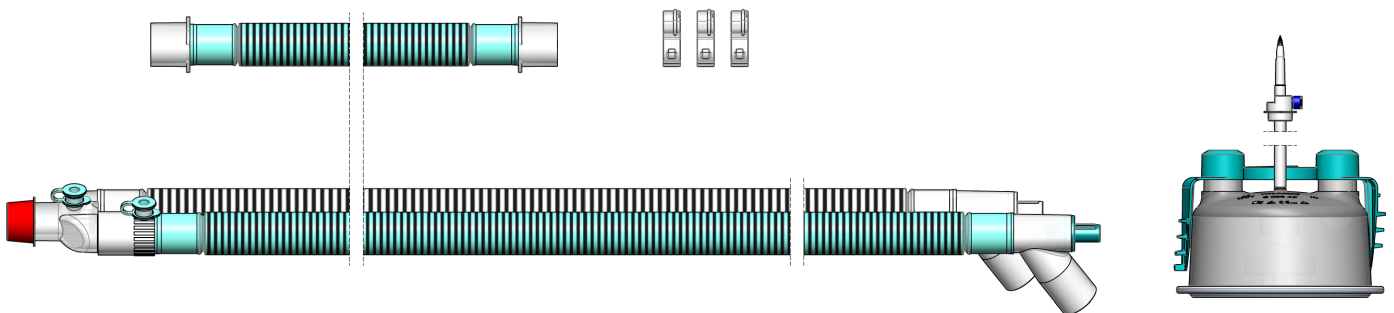

Disposable breathing set heated (i+e), double limb, A-Adapter, Autofill chamber, 150cm, 22mm Ø, Connecting tube 60cm

Item	Part number	QTY	GTIN
BTS3167A, Breathing set, incl. AF humidification chamber	27176010	10	4055146300787



Breathing set heated, single limb, Pediatric

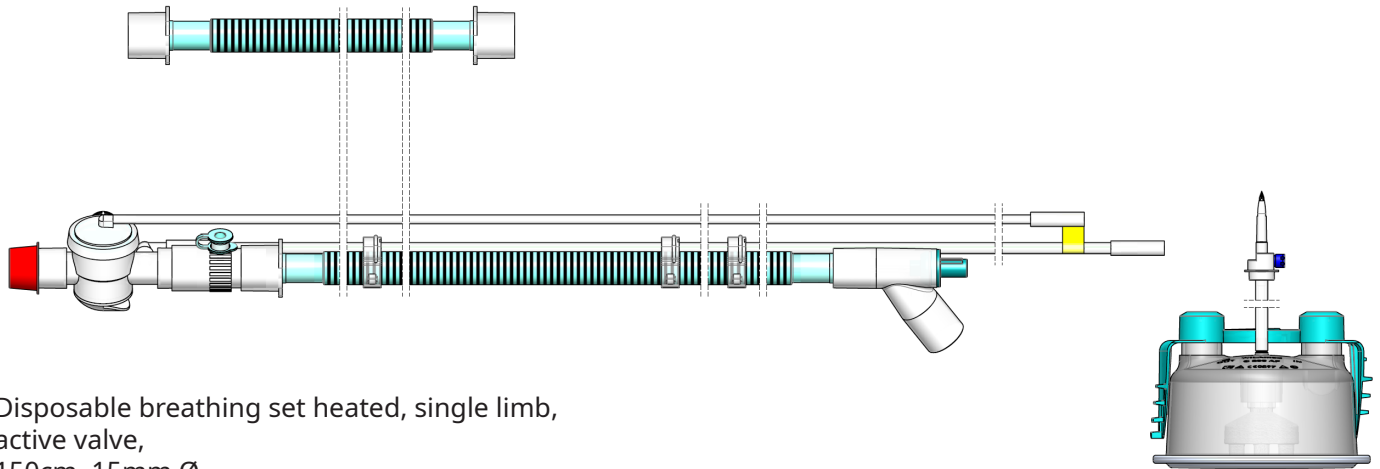

Disposable breathing set heated, single limb,
active valve,
150cm, 15mm Ø,
Humidification chamber,
Connecting tube 60cm

Item	Part number	QTY	GTIN
BTS2200A, Breathing set heated, incl. AF humidification chamber	27125210	10	4055146042267

Breathing set heated, double limb, Pediatric

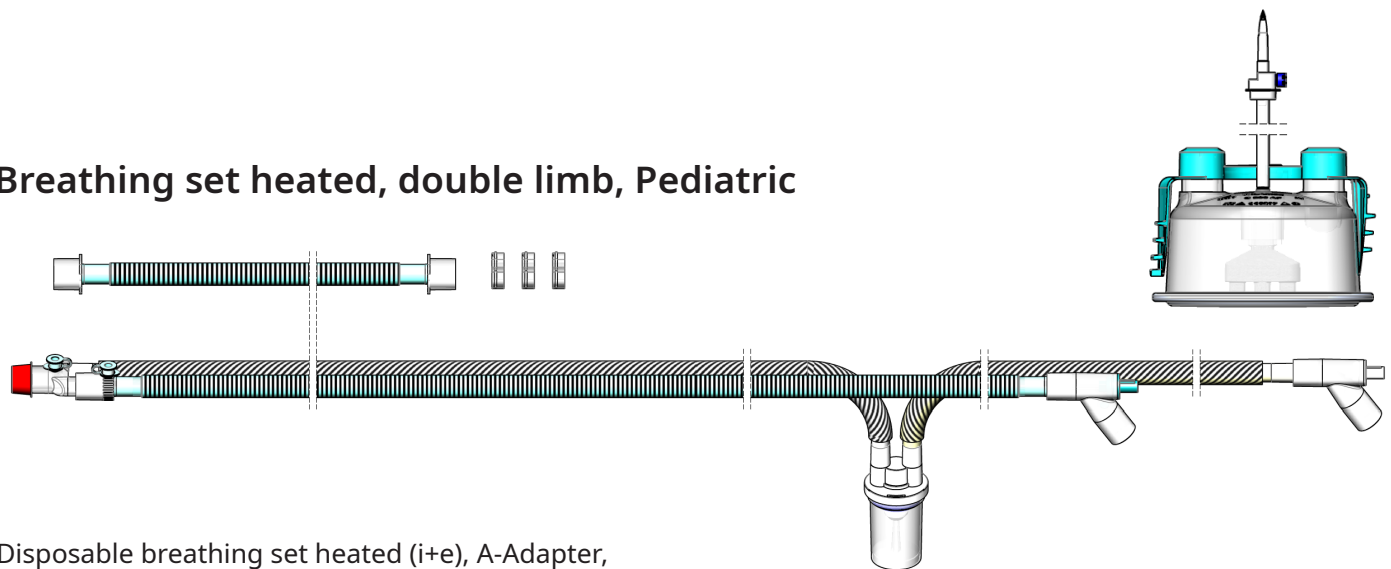

Disposable breathing set heated (i+e), A-Adapter,
150cm, 15mm Ø,
autofill chamber, water trap (e),
expiratory side 200cm,
Connecting tube 60cm

Item	Part number	QTY	GTIN
BTS6038A, Breathing set heated, incl. AF humidification chamber	27150810	10	4055146030929



For use with Breas Vivo 50/55 and Vivo 60/65 Ventilators

Breathing set heated, single limb, Adults

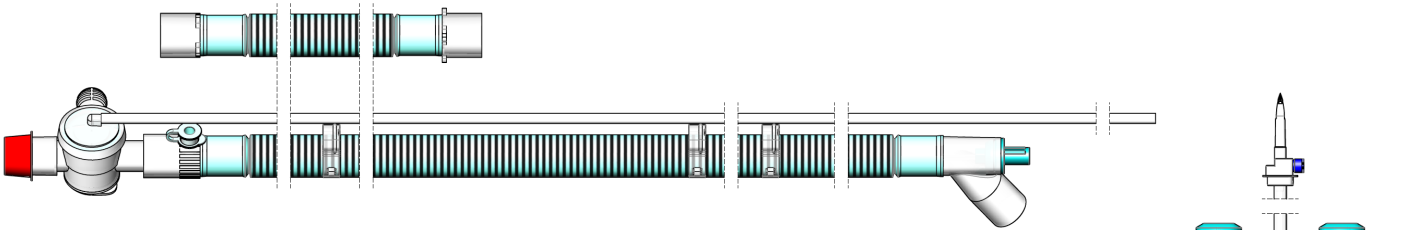

Disposable breathing set heated (i), single limb,
A-Adapter, Autofill chamber,
150cm, 22mm Ø,
active valve,
Connecting tube 60cm

Item	Part number	QTY	GTIN
BTS3238A, Breathing set heated, incl. AF humidification chamber	27112810	10	4055146031049

Breathing set heated, double limb, Adults

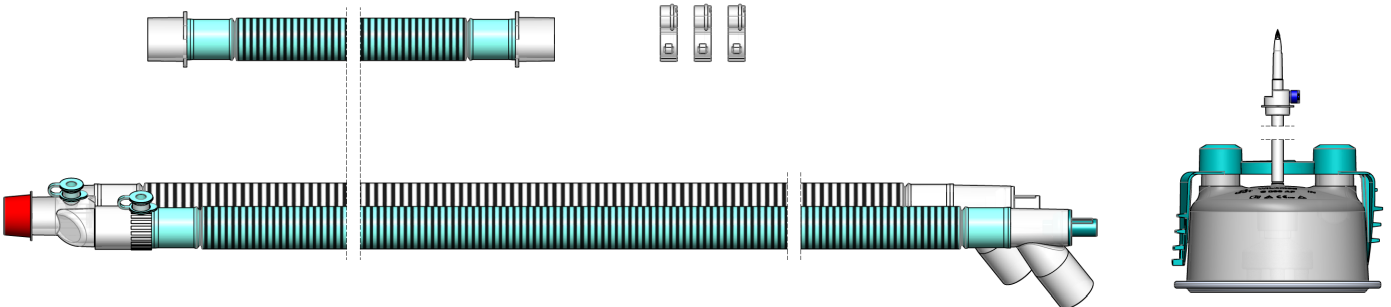

Disposable breathing set heated (i+e), double limb,
A-Adapter, Autofill chamber,
150cm, 22mm Ø,
Connecting tube 60cm

Item	Part number	QTY	GTIN
BTS3481A, Breathing set heated, incl. AF humidification chamber	27176010	10	4055146300787

Breathing set heated, single limb, Pediatric

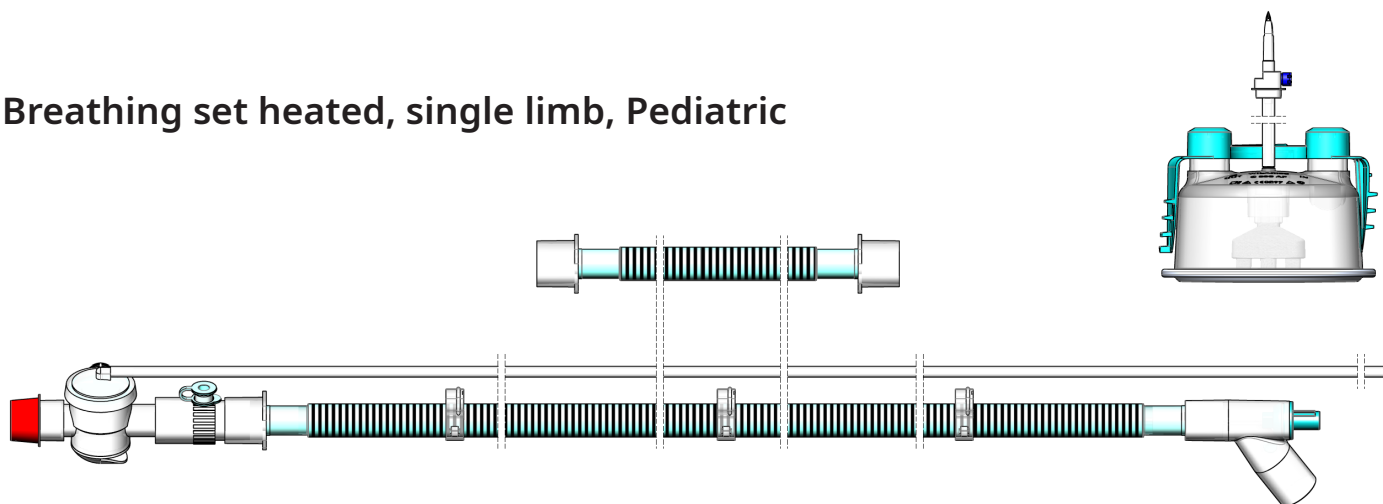

Disposable breathing set heated (i), single limb,
A-Adapter, Autofill chamber,
150cm, 15mm Ø,
active valve,
Connecting tube 60cm

Item	Part number	QTY	GTIN
BTS2125A, Breathing set heated, incl. AF humidification chamber	27113210	10	4055146031032

Breathing set heated, double limb, Pediatric

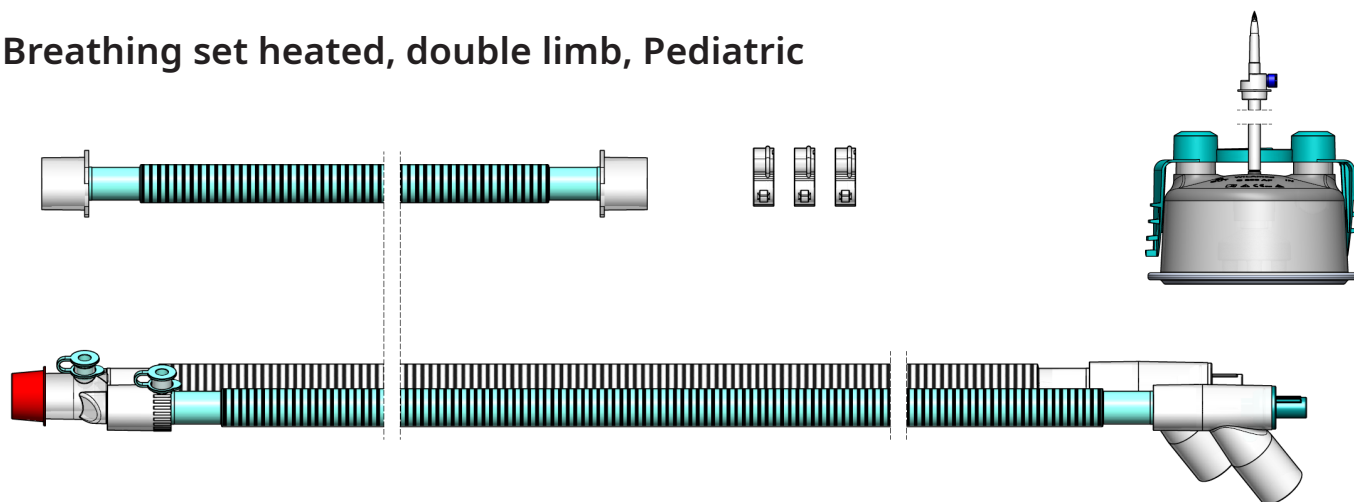

Disposable breathing set heated (i+e), double limb,
A-Adapter, Autofill chamber,
150cm, 15mm Ø,
Connecting tube 60cm

Item	Part number	QTY	GTIN
BTS2260A, Breathing set heated, incl. AF humidification chamber	27176110	10	4055146300770



For use with Trilogy 100 Ventilators

Breathing set heated, single limb, Adults

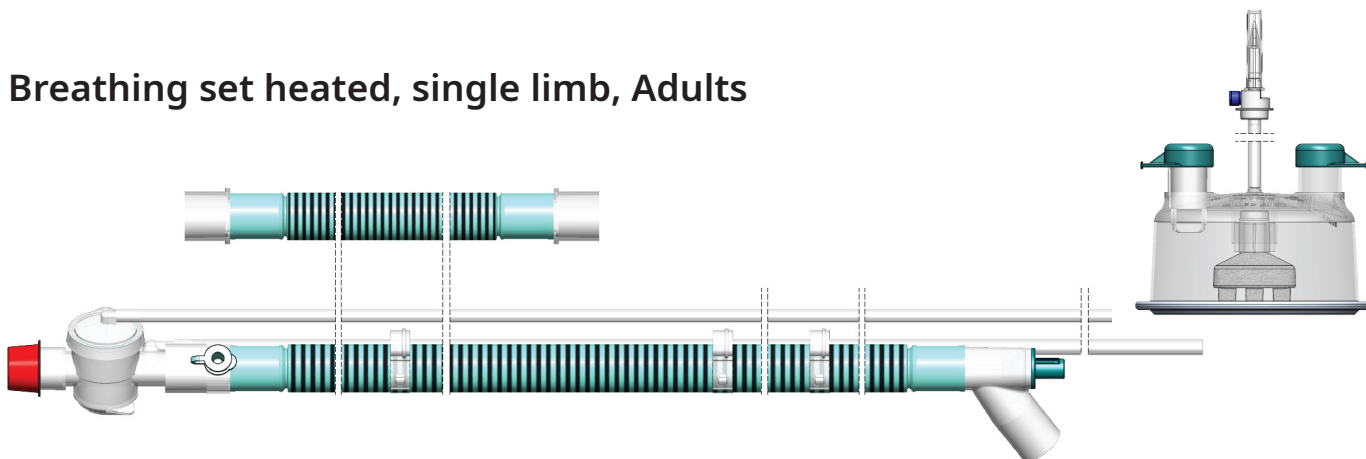

Disposable breathing set heated (i), single limb,
A-Adapter,
Autofill chamber,
150cm, 22mm Ø,
active valve,
Connecting tube 60cm

Item	Part number	QTY	GTIN
BTS3256A, Breathing set heated, AV, incl. humidification chamber	27114310	10	4055146031414

Breathing set heated, single limb, Adults

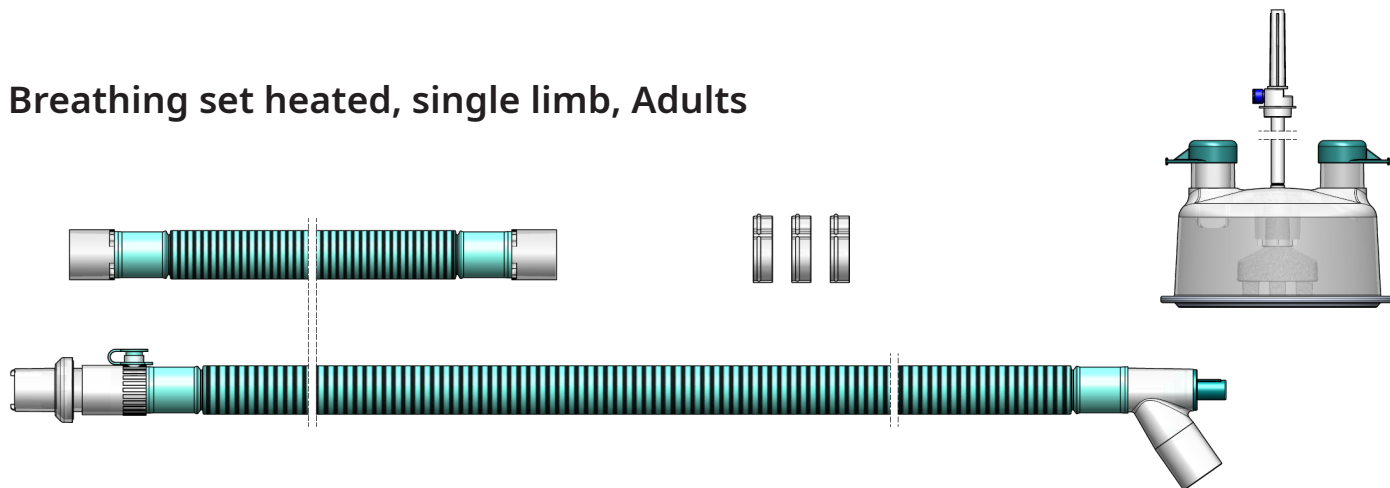

Disposable breathing set heated (i), single limb,
passive valve,
A-Adapter, Autofill chamber,
150cm, 22mm Ø,
Connecting tube 60cm

Item	Part number	QTY	GTIN
BTS3268A, Breathing set heated, PV, incl. AF humidification chamber	27115610	10	4055146031452



Breathing set heated, single limb, Pediatric

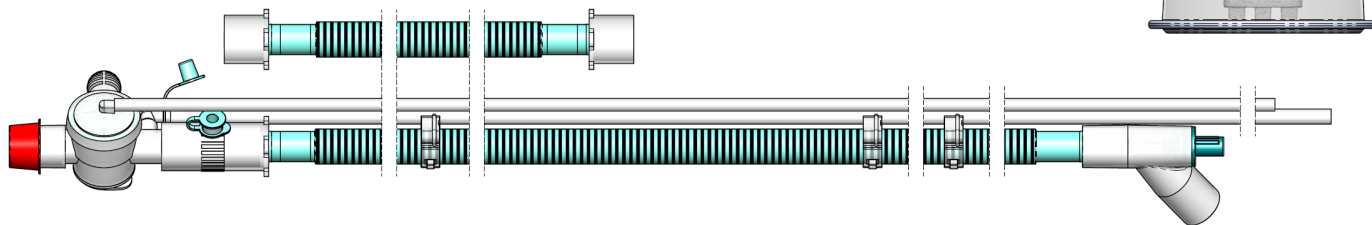

Disposable breathing set heated (i), single limb,
A-Adapter,
active valve,
Autofill chamber,
150cm, 15mm Ø,
Connecting tube 60cm

Item	Part number	QTY	GTIN
BTS2140A, Breathing set heated, AV, incl. AF humidification chamber	27115410	10	4055146031339

Breathing set heated, single limb, Pediatric

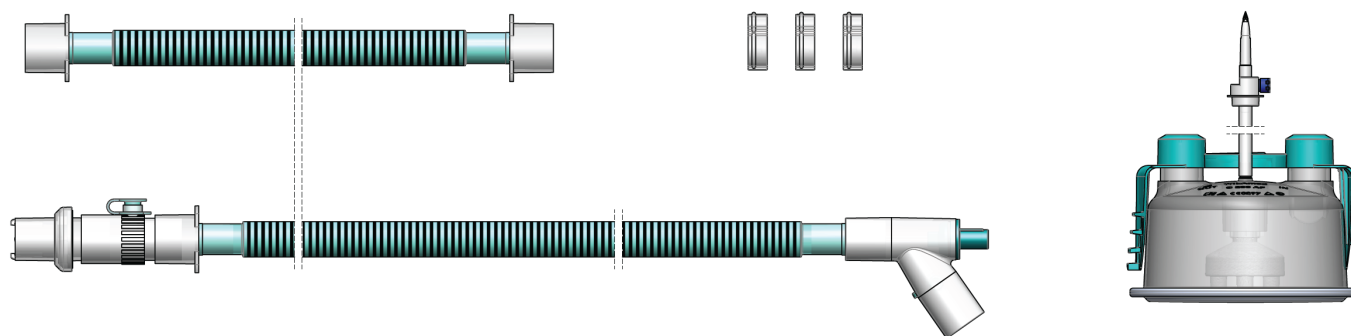

Disposable breathing set-Leakage Set, heated (i), single limb,
passive valve,
A-Adapter,
Autofill chamber,
150cm, 15mm Ø,
Connecting tube 60cm

Item	Part number	QTY	GTIN
BTS2142A, Breathing set heated, PV, incl. AF humidification chamber	27115710	10	4055146031315



For use with Trilogy EVO Ventilators

Breathing set heated, double limb, Pediatric

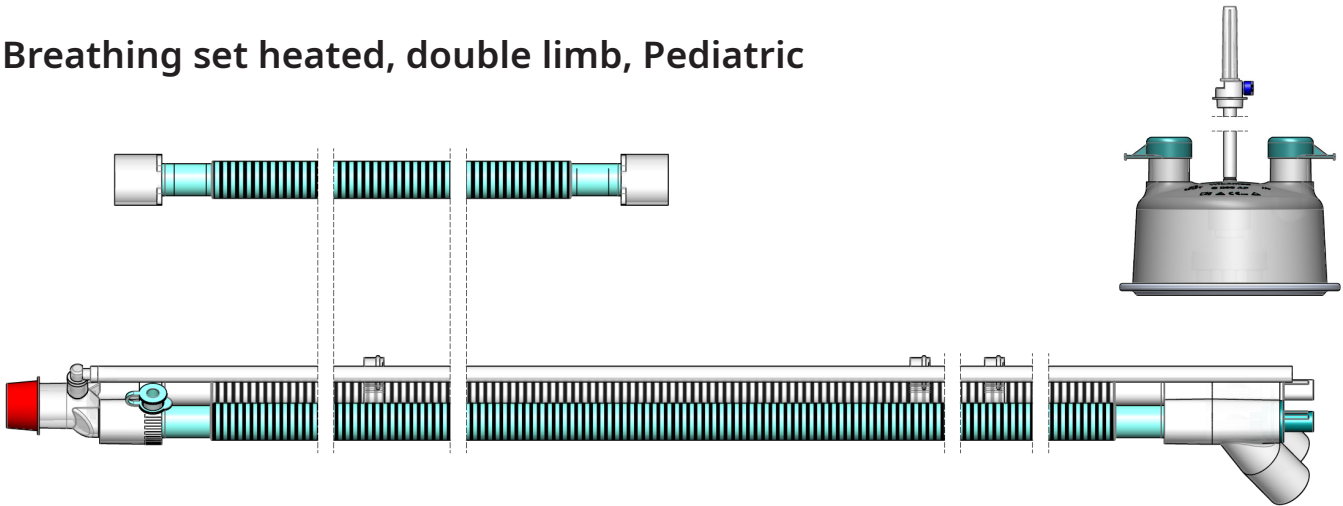

Disposable breathing set heated (i+e), double limb,
A-Adapter,
pressure measuring line,
Autofill chamber,
150cm, 15mm Ø,
Connecting tube 60cm

Item	Part number	QTY	GTIN
BTS6078A, Breathing set heated, incl. AF humidification chamber	27174610	10	4055146499528

Breathing set heated, double limb, Adults

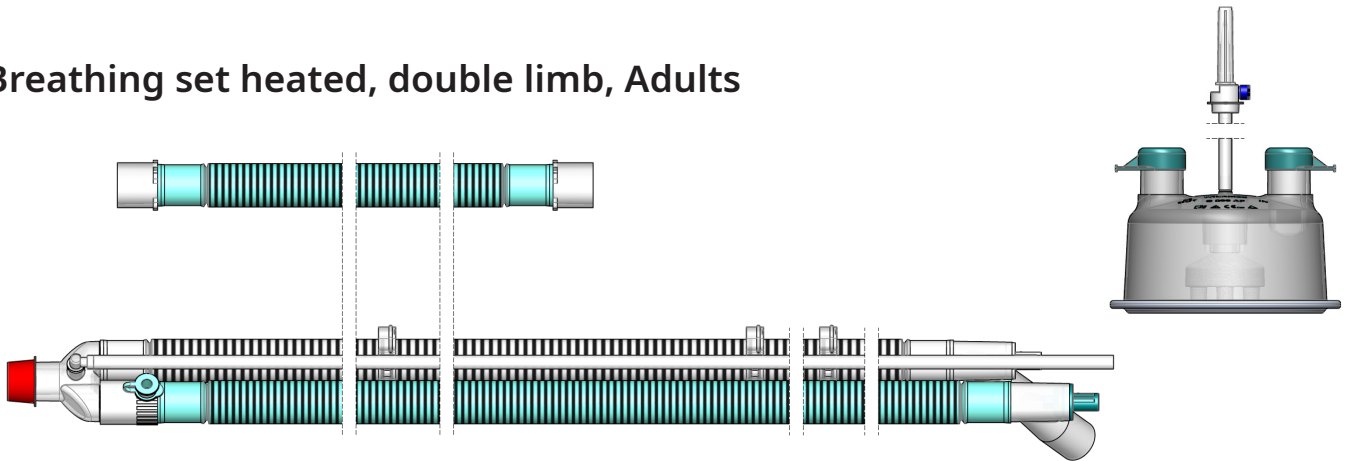

Disposable breathing set heated (i+e), double limb,
A-Adapter,
pressure measuring line,
Autofill chamber,
150cm, 22mm Ø,
Connecting tube 60cm

Item	Part number	QTY	GTIN
BTS8121A, Breathing set heated, incl. AF humidification chamber	27174710	10	4055146300695



Breathing set heated, single limb, Adult

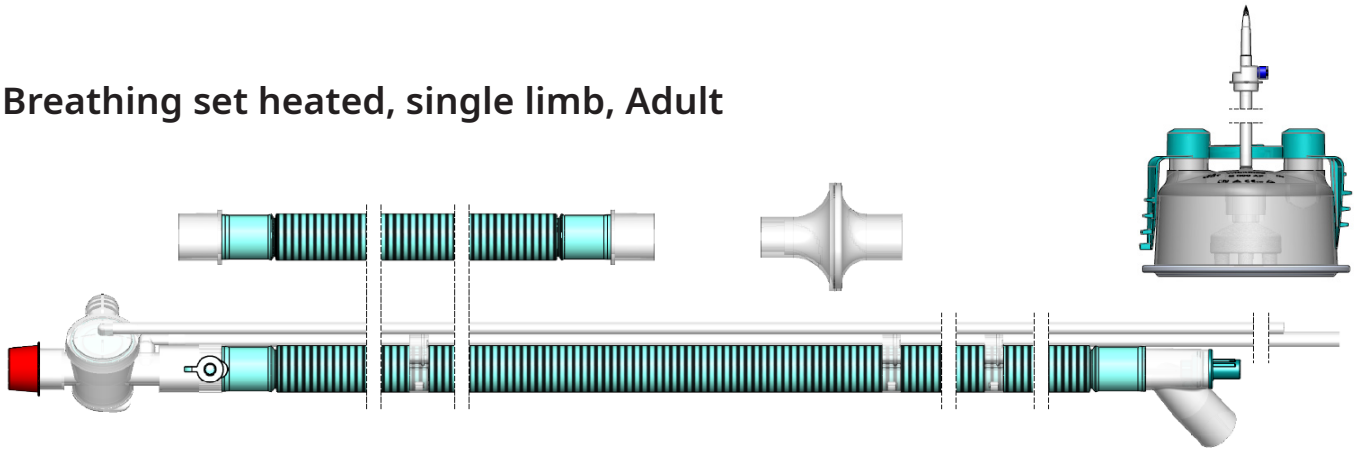

Disposable breathing set heated, single limb
active valve,
Autofill chamber - Ø22 mm, 150 cm

Item	Part number	QTY	GTIN
BTS8074A, Breathing set heated, incl. AF humidification chamber	27168510	10	4055146300626

Breathing set heated, single limb, Pediatric

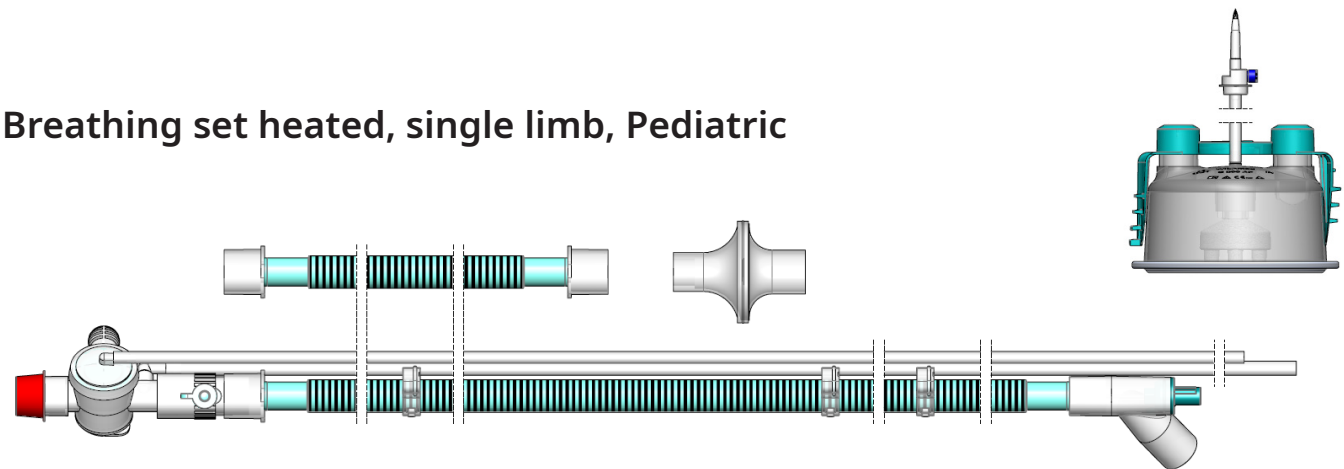

Disposable breathing set heated, single limb
active valve,
Autofill chamber - Ø15 mm, 150 cm

Item	Part number	QTY	GTIN
BTS6054A, Breathing set heated, incl. AF humidification chamber	27168410	10	4055146300299



Breathing set heated, single limb, Pediatric

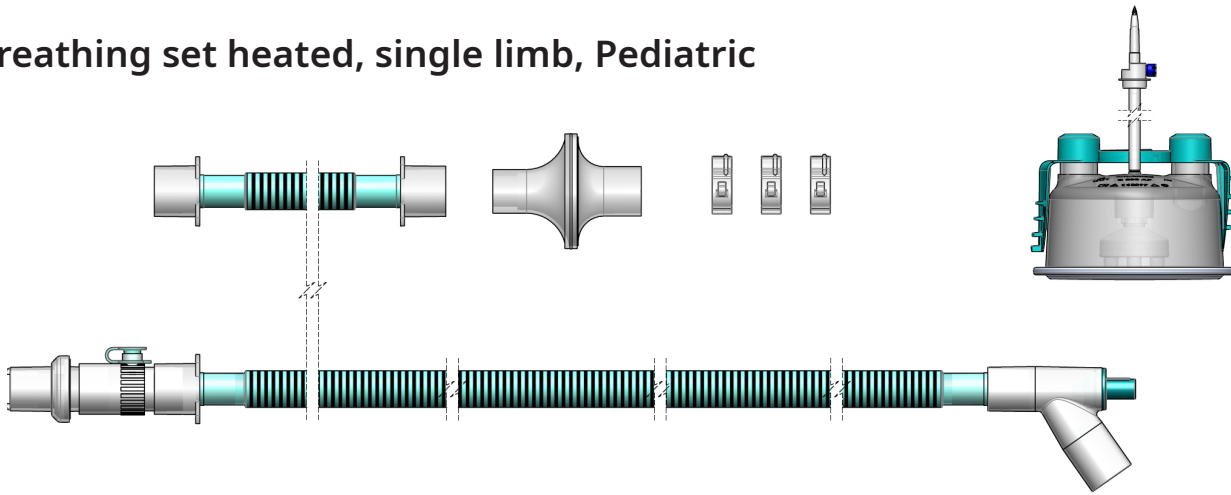

Disposable breathing set heated, single limb
 passive valve,
 Autofill chamber - Ø15 mm, 150 cm

Item	Part number	QTY	GTIN
BTS2247A, Breathing set heated, incl. AF humidification chamber	27168110	10	4055146300237



For use with LÖWENSTEIN prisma VENT50

Breathing set heated, single limb

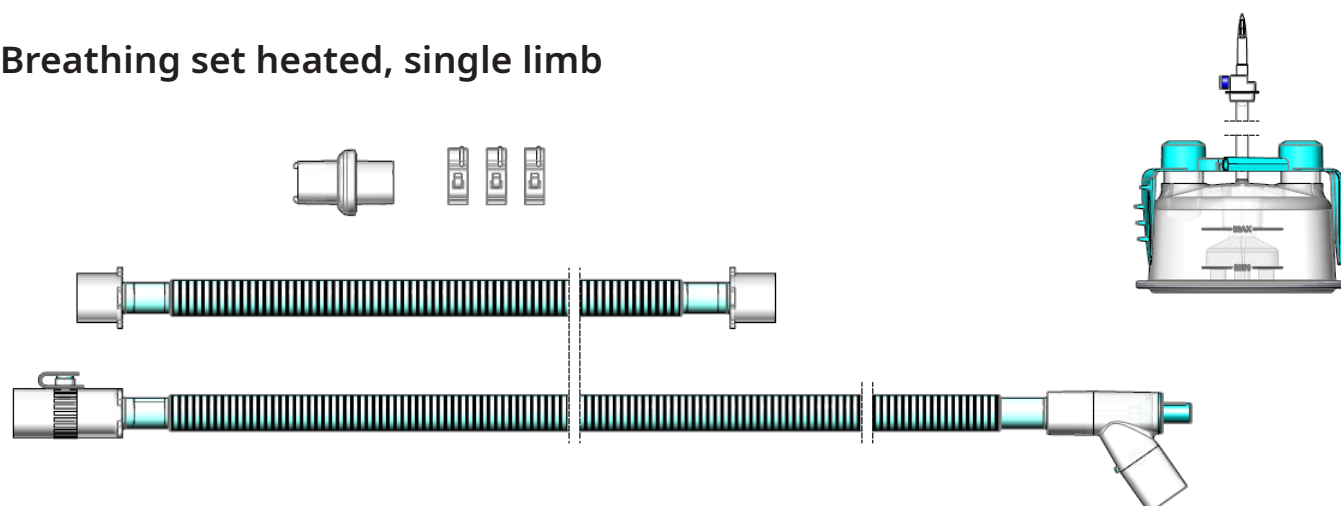

Disposable breathing set heated, single limb
passive valve,
Autofill chamber - 150 cm

Item	Part number	QTY	GTIN
BTS6064A, Breathing set heated, Ø15 mm	27170410	10	4055146302613
BTS8099A, Breathing set heated, Ø22 mm	27170510	10	4055146302798

Breathing set heated, single limb

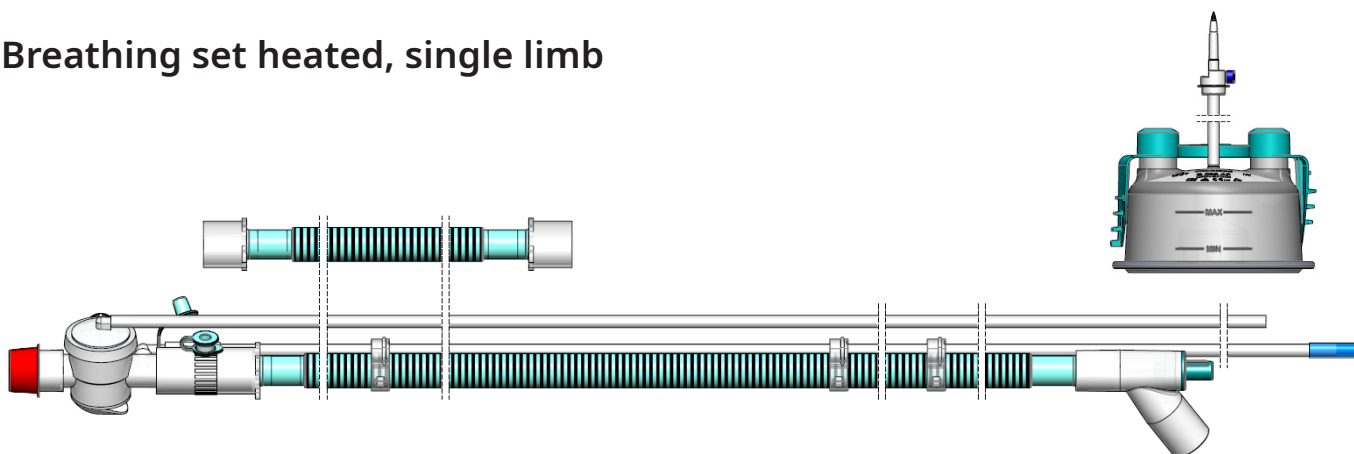

Disposable breathing set heated, single limb
passive valve,
Autofill chamber - 150 cm

Item	Part number	QTY	GTIN
BTS6066A, Breathing set heated, Ø15 mm	27170710	10	4055146302620
BTS8100A, Breathing set heated, Ø22 mm	27170810	10	4055146302804

For use with LÖWENSTEIN Luisa

Breathing set heated, double limb

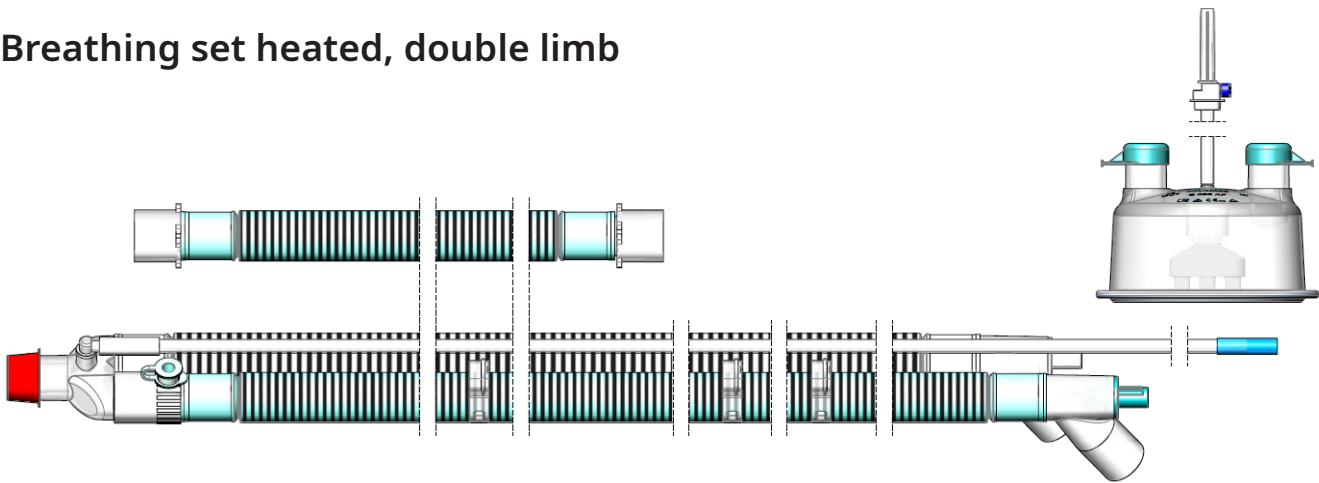

Disposable breathing set heated, double limb,
Autofill chamber - Ø22 mm, 150 cm
LMT part number: 31583

Item	Part number	QTY	GTIN
BTS8117A, Breathing set heated, incl. AF humidification chamber	27173510	10	4055146300640

Breathing set heated, double limb

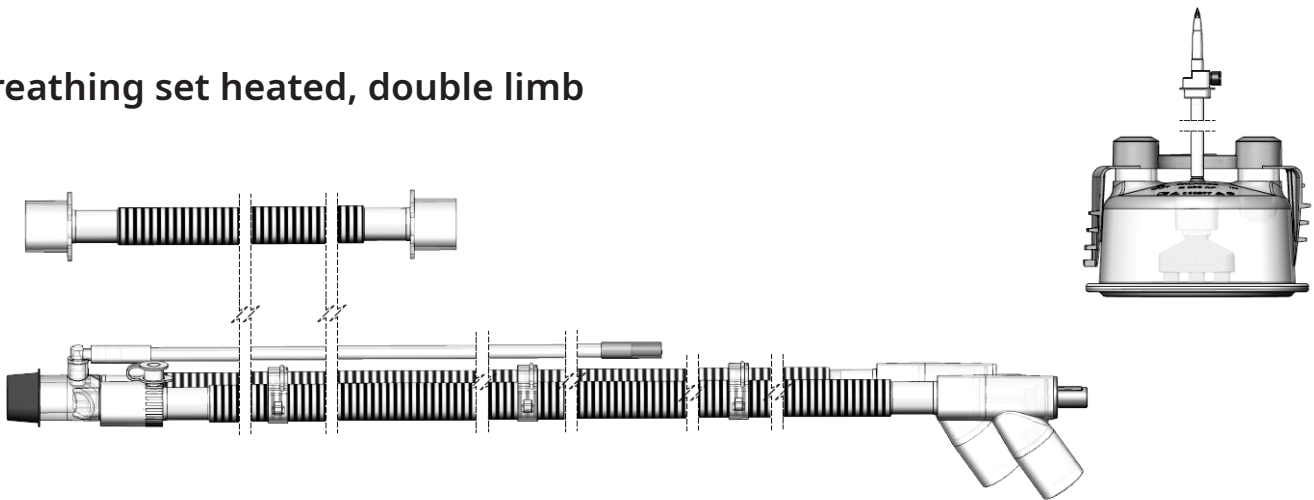

Disposable breathing set heated, double limb,
Autofill chamber - Ø15 mm, 150 cm
LMT part number: 31582

Item	Part number	QTY	GTIN
BTS6075A, Breathing set heated, incl. AF humidification chamber	27173610	10	4055146302644



Breathing set heated, single limb

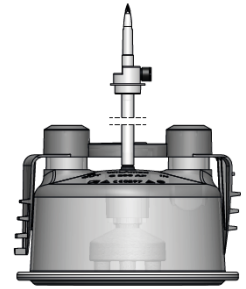
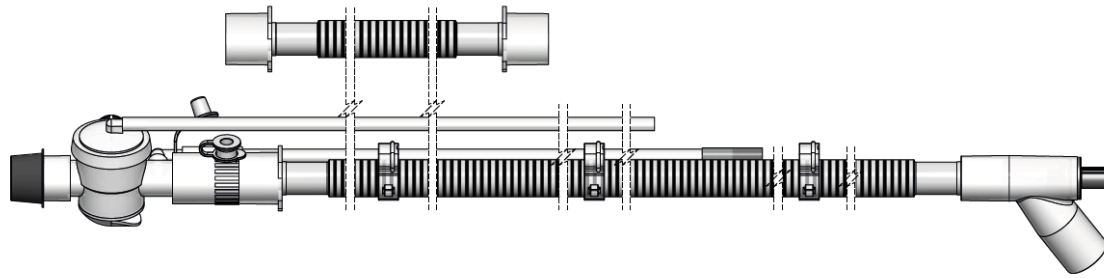

Disposable breathing set heated, single limb
active valve,
Autofill chamber - Ø15 mm, 150 cm
LMT part number: 31384

Item	Part number	QTY	GTIN
BTS6076A, Breathing set heated, incl. AF humidification chamber	27173810	10	4055146302651

Breathing set heated, single limb

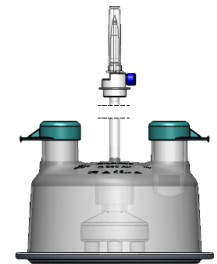
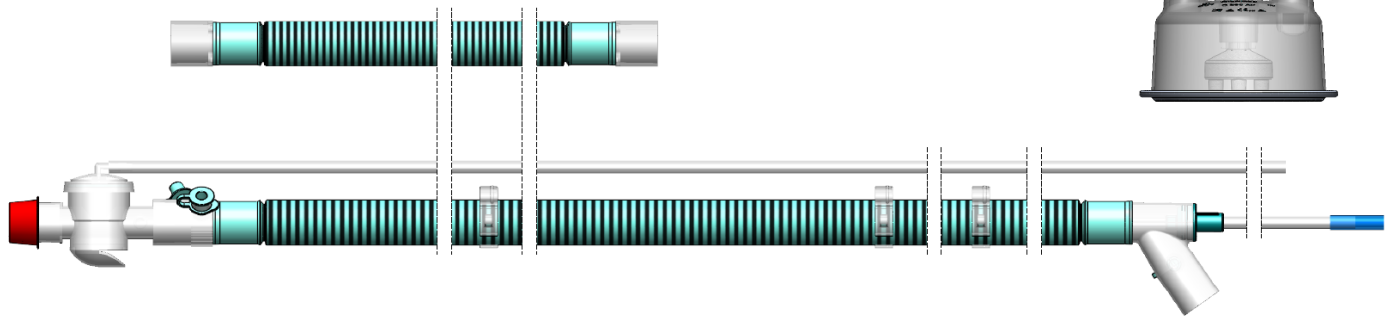

Disposable breathing set heated, single limb
active valve,
Autofill chamber - Ø22 mm, 150 cm
LMT part number: 31385

Item	Part number	QTY	GTIN
BTS8119A, Breathing set heated, incl. AF humidification chamber	27173910	10	4055146302835



Breathing set heated, double limb

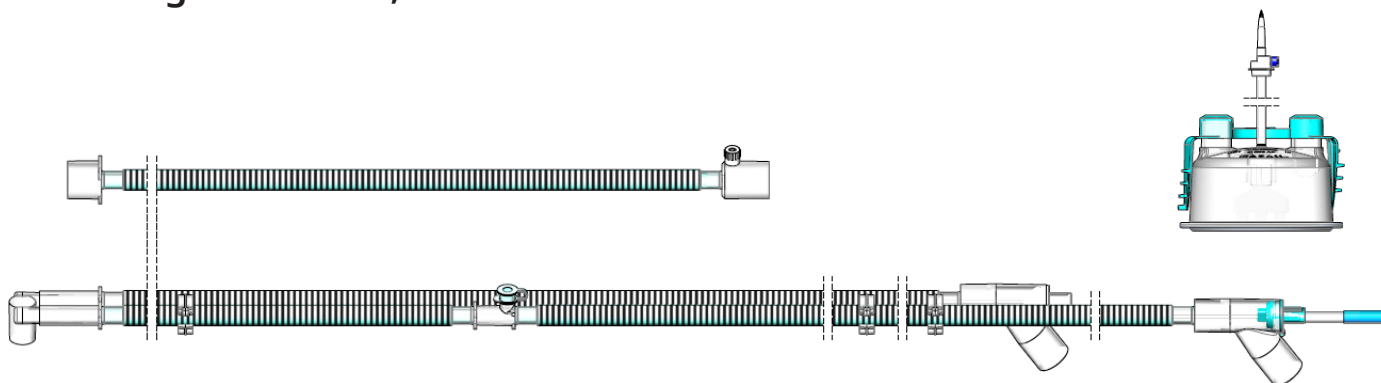

Disposable breathing set heated, double limb,
Autofill chamber - Ø10 mm, 120 cm
LMT part number: 31386

Item	Part number	QTY	GTIN
BTS4042A , Breathing set heated, incl. AF humidification chamber	27174010	10	4055146302514

Breathing set heated, double limb

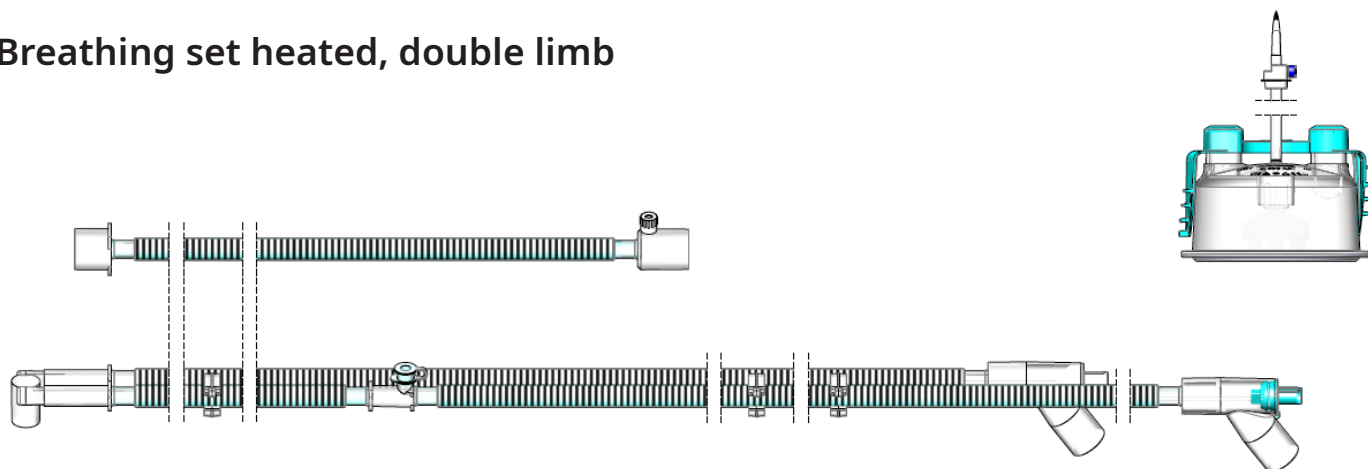

Disposable breathing set heated, double limb,
Autofill chamber - Ø10 mm, 120 cm
LMT part number: 31072

Item	Part number	QTY	GTIN
BTS1361A, Breathing set heated, incl. AF humidification chamber	27175510	10	4055146301951



Breathing set heated, double limb

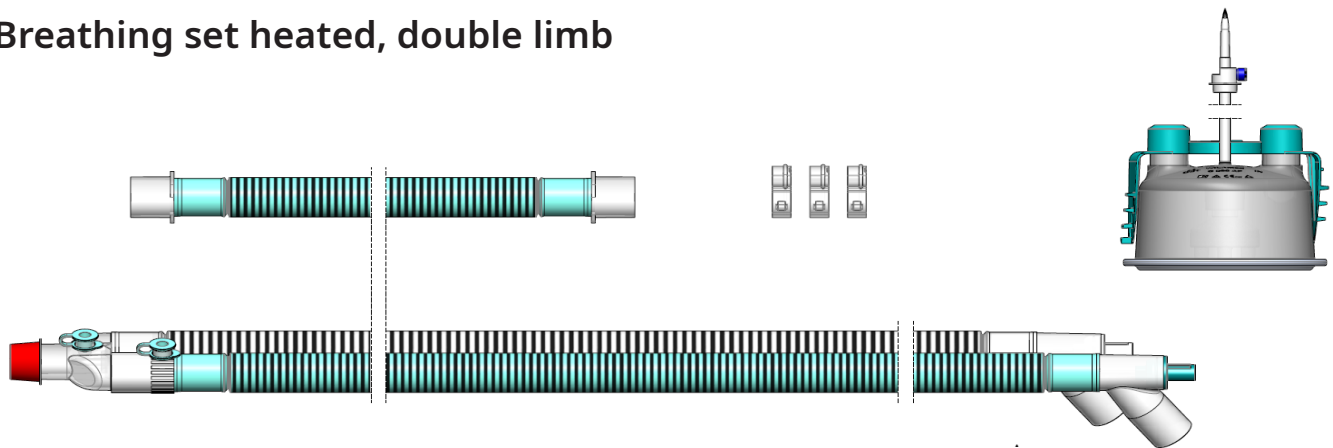

Disposable breathing set heated, double limb,
Autofill chamber - Ø22 mm, 150 cm
LMT part number: 31075

Item	Part number	QTY	GTIN
BTS8128A, Breathing set heated, incl. AF humidification chamber	27175810	10	4055146302859



BREATHING SETS UNHEATED - HOME CARE

For use with Resmed Astral Ventilators

Breathing set unheated, single limb, Adults

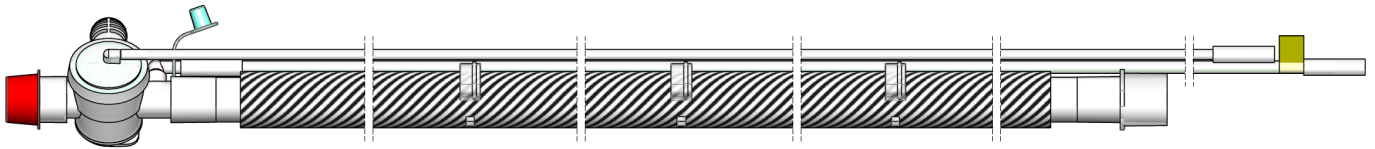

Disposable breathing set unheated, single limb,
active valve,
pressure measuring line,
control line,
180cm, 22mm Ø

Item	Part number	QTY	GTIN
BTS3390, Breathing set unheated, single limb	27124910	10	4055146042168

Breathing set unheated, double limb, Adults

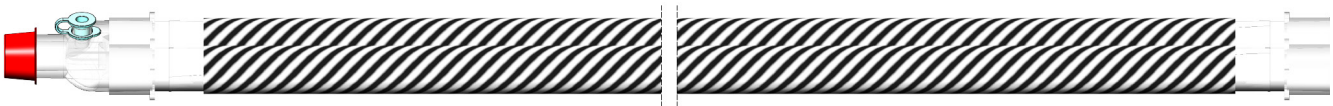

Disposable breathing set unheated, double limb
180cm, 22mm Ø

Item	Part number	QTY	GTIN
BTS300 - Breathing set unheated, double limb	27100310	10	4055146040935

Breathing set unheated, double limb, Pediatric

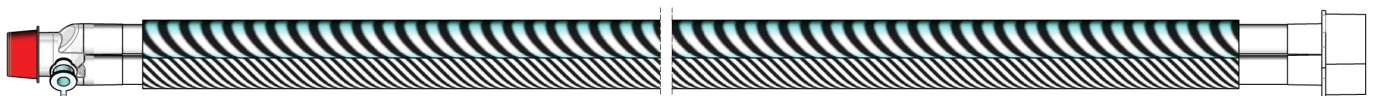

Disposable breathing set unheated, double limb
150cm, 15mm Ø

Item	Part number	QTY	GTIN
BTS200 - Breathing set unheated	27032910	10	4055146040294



Breathing set unheated, single limb, Pediatric

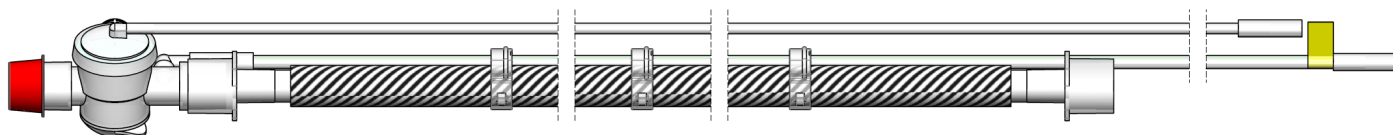

Disposable breathing set unheated, single limb,
active valve,
pressure measuring line,
control line,
150cm, 15mm Ø

Item	Part number	QTY	GTIN
BTS2199 - Breathing set unheated	27125110	10	4055146042335

For use with Breas Vivo 50/55 and Vivo 60/65 Ventilators

Breathing set unheated, single limb, Adults

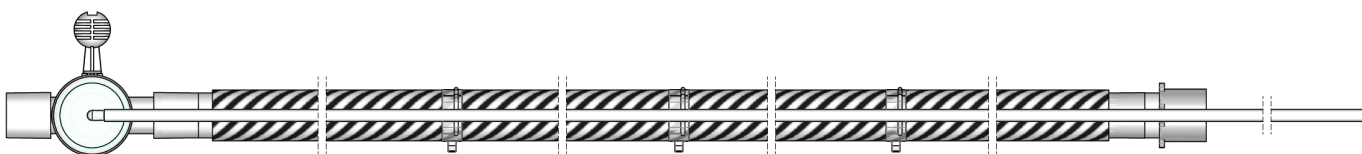

Disposable breathing set unheated, double limb,
active valve,
180cm, 22mm Ø

Item	Part number	QTY	GTIN
BTS3172, Breathing set unheated	27068510	10	4055146041413

Breathing set unheated, double limb, Adults

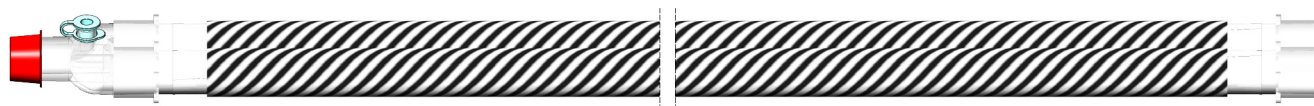

Disposable breathing set unheated, double limb,
180cm, 22mm Ø

Item	Part number	QTY	GTIN
BTS300 - Breathing set unheated	27100310	10	4055146040935



Breathing set unheated, single limb, Pediatric

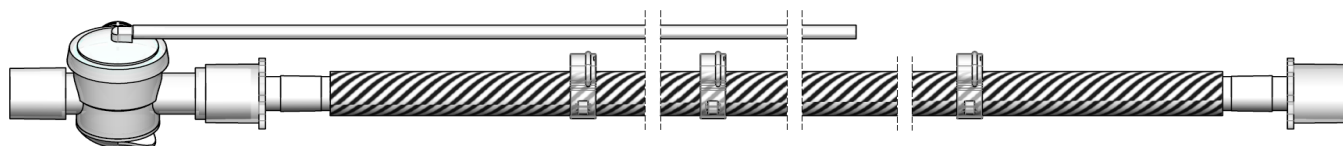

Disposable breathing set unheated, single limb,
active valve,
150cm, 15mm Ø

Item	Part number	QTY	GTIN
BTS2127, Breathing set unheated	27113610	10	4055146031018

Breathing set unheated, double limb, Pediatric

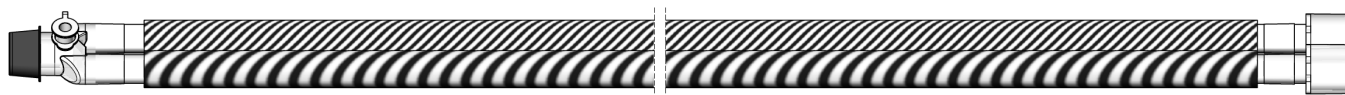

Disposable breathing set unheated, single limb,
150cm, 15mm Ø

Item	Part number	QTY	GTIN
BTS200 - Breathing set unheated	27032910	10	4055146040294

Breathing set unheated, double limb, with smooth-bore

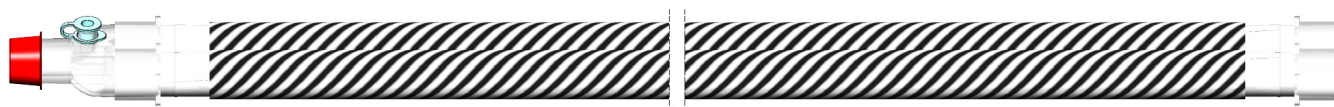

Standard Ventilation Set (Dry)

2 x 180 cm, 22 mm Ø for Adults (271003), Smooth lumen
2 x 150 cm, 15 mm Ø for Pediatric (270329), Smooth lumen

Item	Part number	QTY	GTIN
BTS300, Breathing set unheated, double limb, Adults	27100310	10	4055146040935
BTS200, Breathing set unheated with glatten Lumen, Pediatric	27032910	10	4055146040294



For use with LÖWENSTEIN prisma VENT50

Breathing set unheated, single limb

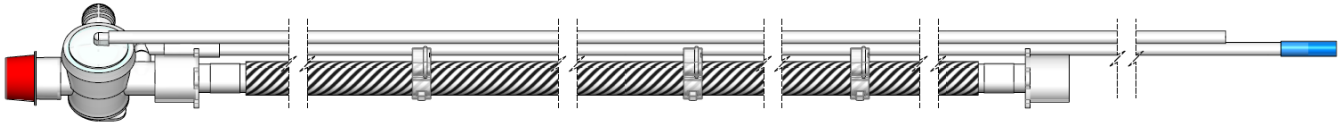

Disposable breathing set unheated, single limb,
active valve,
Ø15 mm, 150 cm

Item	Part number	QTY	GTIN
BTS6068, Breathing set unheated, single limb	27170610	10	4055147000976

For use with LÖWENSTEIN Luisa

Breathing set unheated, double limb



Disposable breathing set unheated, double limb,
Ø15 mm, 150 cm
LMT part number: 31577

Item	Part number	QTY	GTIN
BTS6068, Breathing set unheated, double limb	27173210	10	4055147000990



Breathing set unheated, single limb

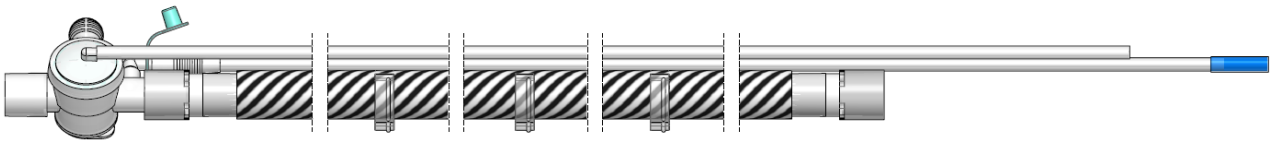

Disposable breathing set unheated, single limb,
active valve - Ø22 mm, 180 cm
LMT part number: 31382

Item	Part number	QTY	GTIN
BTS8116, Breathing set unheated, single limb	27173310	10	4055147000990

Breathing set unheated, single limb

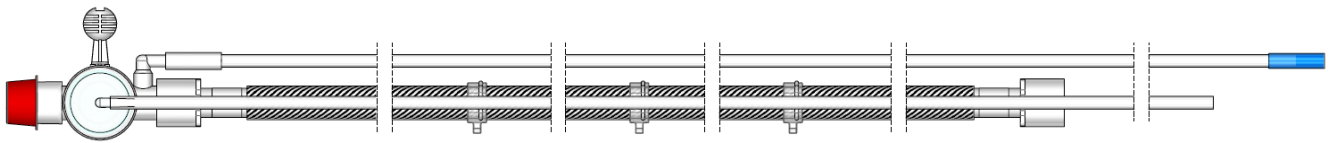

Disposable breathing set unheated, single limb,
active valve - Ø15 mm, 150 cm
LMT part number: 31383

Item	Part number	QTY	GTIN
BTS6074, Breathing set unheated, single limb	27173410	10	4055147000990

Breathing set unheated, double limb

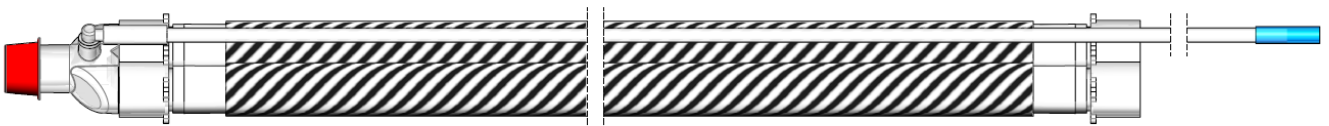

Disposable breathing set unheated, double limb,
Ø22 mm, 180 cm
LMT part number: 31581

Item	Part number	QTY	GTIN
BTS8118, Breathing set unheated, double limb	27173710	10	4055147001164



Breathing set unheated, double limb

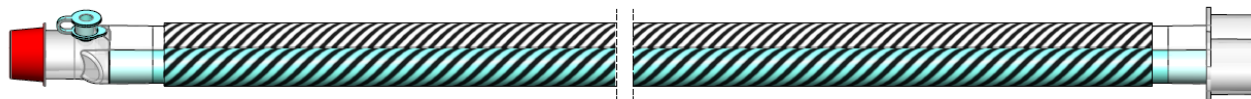

Disposable breathing set unheated, double limb,
Ø15 mm, 150 cm
LMT part number: 31074

Item	Part number	QTY	GTIN
BTS2259, Breathing set unheated, double limb	27175710	10	4055147000990

WILAsilent 2 passive exhalation valve



Item	Part number	QTY	GTIN
WILAsilent 2, passive exhalation valve, individually packed	260622	1	4055146800263



CLEARline

For use with Cough Assisting Devices

Breathing set unheated with smooth-bore for mechanical Insufflation-Exsufflation (MI-E)

Breathing set unheated, single limb

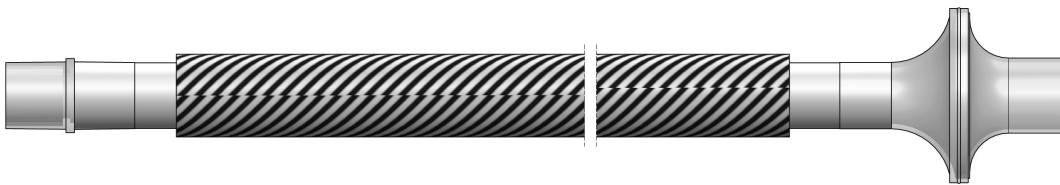

Disposable breathing set unheated, single limb,
for mechanical Insufflation-Exsufflation (MI-E),
Ø22 mm, 180 cm

LÖWENSTEIN Caro, PHILIPS RESPIRONICS Cough Assist, SEOIL PACIFIC Comfort Cough

Item	Part number	QTY	GTIN
BTS3301, Breathing set unheated, single limb	27093110	10	4055147000549

Breathing set unheated, single limb

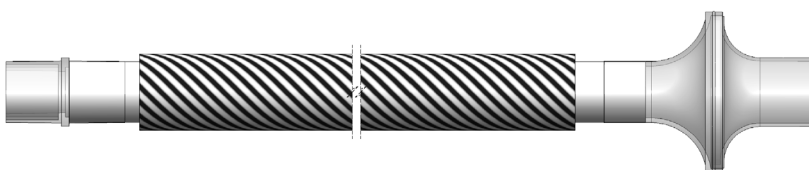

Disposable breathing set unheated, single limb,
for mechanical Insufflation-Exsufflation (MI-E),
Ø22 mm, 90 cm,

LÖWENSTEIN Caro, PHILIPS RESPIRONICS Cough Assist, SEOIL PACIFIC Comfort Cough

Item	Part number	QTY	GTIN
BTS834, Breathing set unheated, single limb	27119110	10	4055146040232



Procedure pack

* Available in the CE region and other countries upon request.



Item	Part number	QTY	GTIN
1x Breathing set, unheated (REF 271191 / BTS834)	27034810	10	4055146040638
1x Anesthesia mask size 3 (REF 038-52-415)			

Procedure pack

* Available in the CE region and other countries upon request.

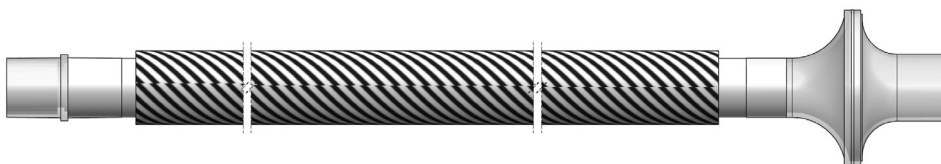

Item	Part number	QTY	GTIN
1x Breathing set, unheated (REF 271191 / BTS834)	27034910	10	4055146040621
1x Anesthesia mask size 5 (REF 038-51-400)			



Procedure pack

* Available in the CE region and other countries upon request.

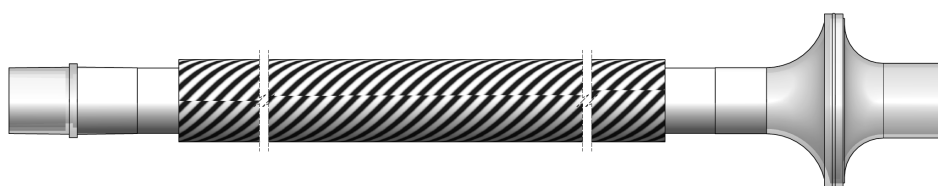

Item	Part number	QTY	GTIN
1x Breathing set, unheated (REF 270931 / BTS3301)			
1x Anesthesia mask size 3 (REF 038-51-400)	27065210	10	4055146040713

Procedure pack

* Available in the CE region and other countries upon request.

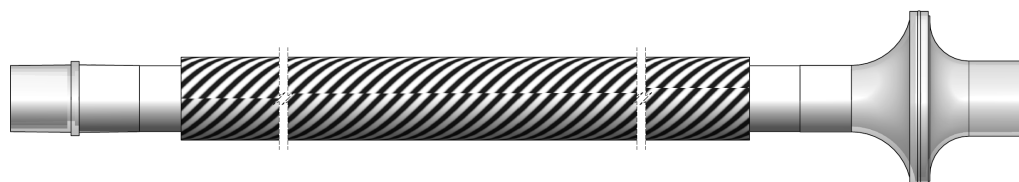

Item	Part number	QTY	GTIN
1x Breathing set, unheated (REF 270931 / BTS3301)			
1x Anesthesia mask size 5 (REF 038-51-400)	27119210	10	4055146040249



DISPOSABLE PATIENT INTERFACES

Our extensive range of patient interfaces for non-invasive ventilation therapy is full of ideas and innovations and offers optimal comfort for the patient, which clearly contributes to the success of the therapy.

Ventura Total Full Face Masks



WILMed's Ventura Total Face Masks are designed and manufactured with patient comfort in mind. Our VENTURA breathing masks are less intimidating than other full face masks because they are open-cut, allowing for better treatment outcomes for anxious or claustrophobic patients.

Item	Part number	QTY	GTIN
Ventura TFM NV/SBE (Blau), Size S	201112	1	4055146600085
Ventura TFM NV/SBE (Blau), Size M	201111	1	4055146600092
Ventura TFM NV/SBE (Blau), Size L	201110	1	4055146600016
Ventura TFM CPAP/AAV (Clear), Size S	201113	1	4055146600023
Ventura TFM CPAP/AAV (Clear), Size M	201114	1	4055146600030
Ventura TFM CPAP/AAV (Clear), Size L	201115	1	4055146600047
Ventura TFM NV/AAV (Gelb), Size S	201107	1	4055146600139
Ventura TFM NV/AAV (Gelb), Size M	201108	1	4055146600146
Ventura TFM NV/AAV (Gelb), Size L	201109	1	4055146600153



JOYCEclinic Full Face Masks

* Engage for more information.



The single-patient-use full-face mask for non-invasive acute ventilation enables both quick and easy mask adjustment as well as a secure and comfortable fit – even at pressures of up to 50 hPa. The headgear, which remains stable even at high pressures, can be quickly and easily released in an emergency using a clearly visible pull strap.

The JOYCEclinic Full Face mask is preconfigured in three sizes and available in the following variants: non-vented, non-vented with AAV, and vented with AAV. The correct size can be determined quickly and accurately using the fitting template – thanks to the dual-chamber bag, even without touching the mask.

Item	Part number	QTY	GTIN
JOYCEclinic Full Face NV AAV, Size S	250240	1	04050384264143
JOYCEclinic Full Face NV AAV, Size M	250241	1	04050384264150
JOYCEclinic Full Face NV AAV, Size L	250242	1	04050384264167
JOYCEclinic Full Face NV, Size S	250243	1	04050384267274
JOYCEclinic Full Face NV, Size M	250244	1	04050384264099
JOYCEclinic Full Face NV, Size L	250245	1	04050384264105
JOYCEclinic Full Face vented, Size S	250246	1	04050384264112
JOYCEclinic Full Face vented, Size M	250247	1	04050384264129
JOYCEclinic Full Face vented, Size L	250248	1	04050384264136



High-Flow Nasal Cannulas

* Only available in selected markets. Engage for more information.



Specifically designed for Nasal High Flow Therapy, the nasal cannula allows delivery of flow rates up to 80 liters per minute. Its compact, flexible design, together with its light weight and low noise, provides maximum patient comfort.

Item	Part number	QTY	GTIN
High Flow Nasenbrille, Size S	20123310	10	16970531333735
High Flow Nasenbrille, Size M	20123410	10	16970531333728
High Flow Nasenbrille, Size L	20123510	10	16970531333711

LMFlo2 High-Flow Nasal Cannulas

* Only available in selected markets. Engage for more information.



WILMed offers a wide range of nasal cannulae for use in nasal high-flow oxygen therapy: from low flow rates when ventilating the smallest patients to very high flow rates for adults.

Item	Part number	QTY	GTIN
LMFlo2 High-Flow Nasal Cannula, Size S (Adult)	201230	10	4719876361202
LMFlo2 High-Flow Nasal Cannula, Size M (Adult)	201231	10	4719876361196
LMFlo2 High-Flow Nasal Cannula, Size L (Adult)	201232	10	4719876360403



Catheter Mount, Double Swivel



Tube extension with angled double rotary connector and suction bronchoscopy opening. Fits all common endotracheal tubes, laryngeal masks and laryngeal tubes.

Item	Part number	QTY	GTIN
Catheter Mount, Double Swivel, 20 cm, 22M/15F-22F	2701031	31	4055146450109
Catheter Mount, Double Swivel, 20 cm, 22M/15F-15M	2705001	31	4055146450079
Catheter Mount, Double Swivel, 15 cm, 22M/15F-22F	2705011	31	4055146450086
Catheter Mount, Double Swivel, 15 cm, 22M/15F-15M	2701021	31	4055146450093



CozyLine & CozyTube

Discover the latest standard in PAP respiratory therapy with our heated breathing tube for both pediatric and adult patients.

The embedded spiral heating wire ensures consistent temperature and humidity levels while effectively minimizing condensation. The smooth inner lumen guarantees an unobstructed airflow, allowing you to focus entirely on your therapy.



CozyLine (with power supply unit)

Item	Part number	QTY	GTIN
BT3489, CozyTube breathing tube heated with power supply unit, 180cm, 15 Ø	271072	1	4055146021736
BT3491, CozyTube breathing tube heated with power supply unit, 180cm, 19 Ø	271073	1	4055146021750

CozyTube (without power supply unit)

Item	Part number	QTY	GTIN
BT2634, CozyTube breathing tube heated, 180cm, 15 Ø	2700621	1	4055146022320
BT2630, CozyTube breathing tube heated, 180cm, 19 Ø	2700631	1	4055146022290



AIRline CPAP

Our high-quality AIRline CPAP breathing tube for sleep therapy is the result of cutting-edge technology combined with premium materials.

With an inner diameter of 15 mm or 19 mm, it enables optimal airflow while minimizing resistance thanks to "Smoothbore" technology. This maximizes the efficiency of sleep therapy, reduces noise levels, and contributes to a restful night's sleep.

The AIRline CPAP breathing tube is compatible with all common CPAP devices and masks, ensuring seamless integration into existing therapy.

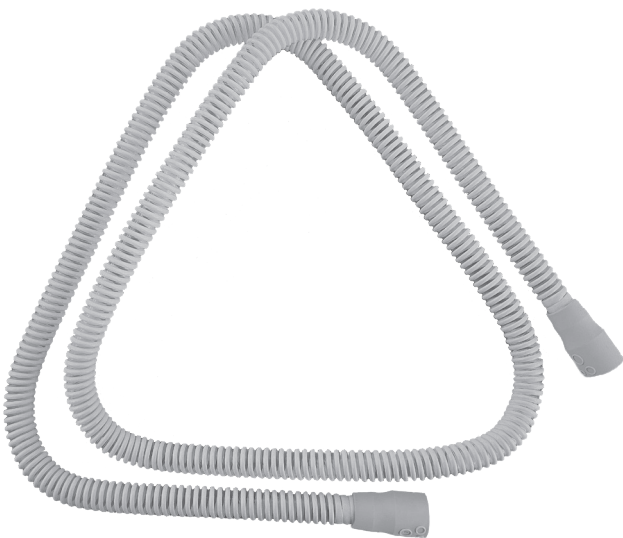

Item	Part number	QTY	GTIN
BT2100, Breathing tube, unheated - Ø15 mm, 180 cm	270446110	10	4055146022115
BT3307, Breathing tube, unheated - Ø19 mm, 60 cm	2701531	1	4055146020128
BT3304, Breathing tube, unheated - Ø19 mm, 120 cm	270146110	10	4055146020562
BT3101, Breathing tube, unheated - Ø19 mm, 180 cm	270166110	10	4055146022122
BT3309, Breathing tube, unheated - Ø19 mm, 270 cm	270173110	10	4055146021255



HEAD GEAR FOR PATIENT INTERFACES

Cap: DALLAS



Item	Part number	QTY	GTIN
Cap DALLAS, Navy Blue, Size M	300012	1	4055146070086
Cap DALLAS, Navy Blue, Size L	300013	1	4055146070154

Cap: NEW YORK



Item	Part number	QTY	GTIN
Cap NEW YORK, White, Size S	300005	1	4055146071052
Cap NEW YORK, White, Size M	300010	1	4055146071090



Head Strap: RIO, MILANO and BARCELONA



Item	Part number	QTY	GTIN
Head Strap RIO, Navy Blue, One-Size	300450	1	4055146070192
Head Strap MILANO, Turquoise, 20mm	201001	1	4055146070581
Head Strap BARCELONA, Turquoise, 15mm	203001	1	4055146070369

Chin Strap: QUÉBEC, TORONTO and OTTAWA



Item	Part number	QTY	GTIN
Chin Strap QUÉBEC, White, One-Size	300310	1	4055146071151
Chin Strap TORONTO, White, One-Size	300315	1	4055146071045
Chin Strap OTTAWA, Navy Blue, One-Size	300316	1	4055146071038



ACCESSORIES

WILAsil CPAP Cleaning agent



CPAP Special cleaning agent, for Nasal- and Full-Face Masks, CPAP Hose and Accessories. Cleaning agent concentrate, to mix with tap water.

Item	Part number	QTY	GTIN
WILAsil Cleaning agent, 250 ml (DE, CH)	5001771	1	4055146083024
WILAsil Cleaning agent, 250 ml (NL)	50017771	1	4055146800348
WILAsil Cleaning agent, 250 ml (IT)	50017781	1	4055146800362
WILAsil Cleaning agent, 250 ml (FR)	50017801	1	4055146800386
Löwosan Cleaning agent, 250 ml (DE)	50017731	1	4055146800324
Löwosan Cleaning agent, 250 ml (NL)	50017751	1	4055146800331

Breathing tube sleeve „WILAcover Nordkap“



Item	Part number	QTY	GTIN
Breathing tube sleeve NORDKAP, grey	270158	10	4055146086384



LÖWENSTEIN
medical

7.04

6.0 cmH2O

- +

Prisma SMART

☰

▶

PRODUCT CATALOGUE



WILamed GmbH

Aurachhöhe 5-7

91126 Kammerstein, Germany

Tel.: +49(0)9178 99 69 99-0

Fax: +49(0)9178 99 67 78

E-Mail: info@wilamed.com

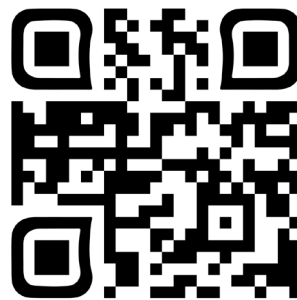

V 2.7 - 2025-08-11